

KENWOOD

40MHz DUAL TRACE READOUT OSCILLOSCOPE

CS-5130

40MHz DUAL TRACE OSCILLOSCOPE

CS-5135

INSTRUCTION MANUAL

KENWOOD CORPORATION

SAFETY

Symbol in This Manual



This symbol indicates where applicable cautionary or other information is to be found.

Power Source

This equipment operates from a power source that does not apply more than 250 V rms between the supply conductors or between either supply conductor and ground. A protective ground connection by way of the grounding conductor in the power cord is essential for safe operation.

Grounding the Product

This equipment is grounded through the grounding conductor of the power cord. To avoid electrical shock, plug the power cord into a properly wired receptacle before connecting to the equipment input or output terminals.

Use the Proper Power Cord

Use only the power cord and connector specified for your product.

Use the Proper Fuse

To avoid fire hazard, use a fuse of the correct type.

Do not Operate in Explosive Atmospheres

To avoid explosion, do not operate this product in an explosive atmosphere.



Do not Remove Cover or Panel

To avoid personal injury, do not remove the cover or panel. Refer servicing to qualified personnel.

Voltage Conversion

If the power source is not applied to your product, contact your dealer. To avoid electrical shock, do not perform the voltage conversion.

CONTENTS

SAFETY	2	1. DC VOLTAGE MEASUREMENTS	21
FEATURES	3	2. MEASUREMENTS OF THE VOLTAGE BETWEEN TWO POINTS ON A WAVEFORM	22
SPECIFICATIONS	4	3. ELIMINATION OF UNDESIRE SIGNAL COMPONENTS	23
 PRECAUTIONS	7	4. VOLTAGE RATIO MEASUREMENT USING CURSORS	23
CONTROLS AND INDICATORS	9	5. TIME MEASUREMENTS	24
FRONT PANEL	9	6. TIME DIFFERENCE MEASUREMENT	24
REAR PANEL	14	7. PULSE WIDTH MEASUREMENTS	25
DIRECTIONS FOR USE	15	8. PULSE RISE TIME AND FALL TIME MEASUREMENTS	26
READOUT DISPLAY (CS-5130 Only)	15	9. PHASE DIFFERENCE MEASUREMENTS	27
OPERATING INSTRUCTIONS	16	10. TIME RATIO MEASUREMENT USING CURSORS ..	28
INITIAL STARTING PROCEDURE	16	11. FREQUENCY MEASUREMENTS	29
[A] OPERATIONS AS A GENERAL-USE OSCILLOSCOPE	16	12. RELATIVE MEASUREMENTS	30
(1) NORMAL SWEEP DISPLAY OPERATION	16	13. PULSE JITTER MEASUREMENTS	31
(2) MAGNIFIED SWEEP OPERATION	18	14. SWEEP MAGNIFICATIONS	32
(3) ALTERNATE SWEEP OPERATION	18	15. APPLICATION OF X-Y OPERATION	32
(4) X-Y OPERATION	19	 MAINTENANCE	34
(5) VIDEO SIGNAL OBSERVATION	19	ACCESSORIES	35
(6) SINGLE SWEEP OPERATION	20		
[B] READOUT OPERATION (CS-5130 Only)	20		
APPLICATION	21		
PROBE COMPENSATION	21		
TRACE ROTATION COMPENSATION	21		



NOTE: This instruction manual is described for two models CS-5130 and CS-5135. Refer to item applied to your product.

FEATURES

1. High vertical axis sensitivity of 1 mV/div and wide bandwidth that covers fully specified frequency response at 5 mV/div.
2. 12-step vertical sensitivity from 1 mV/div to 5 V/div.
3. Vertical mode function provides automatic trigger signal selection correspondent to MODE selector setting.
4. Maximum sweep time sweep at 20 ns/div.
5. Alternate sweep function enables simultaneous observation of a desired waveform and its magnified waveform.
6. One-touch switchover to X-Y operation.
7. Automatic fixing function eliminates troublesome synchronization operation.
8. Equipped with the CH1 OUT connector for monitoring channel-1 input signal.
9. Five-revolution DELAY TIME POSITION potentiometer offers easy setting.
10. The readout function displays, in letters, each scale factor of the vertical axis input sensitivity, sweep time, etc. on the CRT. (CS-5130 only)
11. Cursor measurement mode (CS-5130 only)
The cursor measurement mode displays, in letters, voltage difference, voltage ratio, time difference, time ratio, frequency, and phase difference corresponding to movement of two cursors. This display provides accurate waveform observation and facilitates data collection by photography.

SPECIFICATIONS

		CS-5130	CS-5135
CRT		150 mm rectangular with internal graticule	
Acceleration Voltage		12 kV	
Display Area		8 × 10 div (1 div = 10 mm)	
VERTICAL AXIS (CH1 and CH2)			
Sensitivity		1 mV/div to 5 V/div: 1 mV to 2 mV/div ±5%, 5 mV/div to 5 V/div ±3%	
Attenuator		12 steps, 1 mV/div to 5 V/div in 1-2-5 sequence Vernier control for fully adjustable sensitivity between steps	
Input Impedance		1 MΩ ±2%, approx. 30 pF	
Frequency Response	DC	DC to 40 MHz, within -3 dB (5 mV/div to 5 V/div) DC to 15 MHz, within -3 dB (1 mV/div to 2 mV/div)	
	AC	5 Hz to 40 MHz, within -3 dB (5 mV/div to 5 V/div) 5 Hz to 15 MHz, within -3 dB (1 mV/div to 2 mV/div)	
Rise Time		8.7 ns (5 mV/div to 5 V/div) 17.5 ns (1 mV/div & 2 mV/div)	
Signal Delay Time		Adequate to identify leading edge	
Crosstalk		-40 dB or less (at 1 kHz)	
Operating Modes	CH1	Single trace	
	CH2	Single trace	
	ALT	Two-waveform display, alternately	
	CHOP	Two-waveform display, chopped	
	ADD	CH1 + (±CH2) added display	
Chop Frequency		Approx. 300 kHz	
Channel Polarity		Normal or inverted, channel 2 only inverted	
⚠ Maximum Input Voltage		500 Vp-p or 250 V (DC+AC peak)	
HORIZONTAL AXIS Input thru CH2, ×10 MAG not included			
Operating Modes		X-Y operation is selectable with HORIZ MODE switch CH1 : Y axis CH2 : X axis	
Sensitivity		Same as vertical axis (CH2)	
Input Impedance		Same as vertical axis (CH2)	
Frequency Response	DC	DC to 1 MHz, within -3 dB	
	AC	5 Hz to 1 MHz, within -3 dB	
X-Y Phase Difference		3° or less at 100 kHz	
⚠ Maximum Input Voltage		Same as vertical axis (CH2)	
SWEEP			
Type	A	A sweep	
	ALT	A sweep (intensified for duration of B sweep) and B sweep (delayed sweep) alternating	
	B	Delayed sweep	
	X-Y	X-Y oscilloscope operation	
Sweep Time	A	0.2 μs/div to 0.5 s/div ±3%, in 20 ranges, in 1-2-5 sequence Vernier control for fully adjustable sweep time between steps	
	B	0.2 μs/div to 50 ms/div ±3%, in 17 ranges, in 1-2-5 sequence	
Sweep Magnification		× 10 (ten times) ±5% (±8% in 0.2 μs-to-0.5 μs range)	
Linearity		±3% (±5% for ×10 magnification)	
Holdoff		Continuously variable from NORM to more than ten time (MAX)	
Trace Separation		Shifts B sweep trace continuously in vertical direction by 4 divisions or more with respect to A sweep	
Delayed Sweep		Continuous delay (AFTER DELAY) & triggered delay (B TRIG' D: triggered by A trigger)	
Delay Time		Continuous adjustable from 0.2 μs/div to 0.5 s/div	

		CS-5130	CS-5135
Delay Accuracy		$\pm (3\% \text{ of set value} + 1\% \text{ of full scale}) + (0 \text{ to } 300 \text{ ns})$	$\pm 4\% \text{ of reading on CRT}$
Delayed Jitter		10000 : 1 of decoupled time axis A set value	
TRIGGERING			
Modes		AUTO, NORM, FIX, & SINGLE-RESET	
Trigger Source	VERT MODE	Triggered by input signal selected with vertical MODE selector	
	CH1	Triggered by CH1 vertical signal	
	CH2	Triggered by CH2 vertical signal	
	LINE	Triggered by line frequency	
	EXT	Triggered by external trigger signal	
External Trigger Input Impedance		1 M Ω \pm 2%, approx. 25 pF	
 MAX. EXT. Input Voltage		50 V (DC + AC peak)	
Coupling		AC, HFREJ, DC, TV-FRAME, & TV-LINE	
Trigger Sensitivity	At NORM position		
	AC	Trigger frequency range 10 Hz to 20 MHz (INT: 1 div, EXT: 0.15 Vp-p) 10 Hz to 40 MHz (INT: 1.5 div, EXT: 0.2 Vp-p)	
	DC	Trigger frequency range DC to 20 MHz (INT: 1 div, EXT: 0.15 Vp-p) DC to 40 MHz (INT: 1.5 div, EXT: 0.2 Vp-p)	
	HFREJ	Trigger frequency range is more than 50 kHz, and minimum amplitude (voltage) required for sync is increased.	
	TV	FRAME, LINE INT: 1.0 div, EXT: 0.15 Vp-p	
		AUTO: Same as above specifications for above 50 Hz	FIX: 50 Hz to 20 MHz (INT: 1.5 div, EXT: 200 mV) 50 Hz to 40 MHz (INT: 2.0 div, EXT: 250 mV)
CALIBRATION VOLTAGE		1 V p-p \pm 3%, square wave, positive polarity, approx. 1 kHz	
INTENSITY MODULATION			
Sensitivity		+ 5 V, positive voltage decreases brightness	
Input Impedance		Approx. 10 k Ω	
Usable Frequency Range		DC to 5 MHz	
 Maximum Input Voltage		50 V (DC + AC peak)	
VERTICAL AXIS SIGNAL OUTPUT (CH1 only)			
Output voltage		Approx. 50 mVp-p/div (50 Ω termination)	
Output Impedance		Approx. 50 Ω	
Frequency Response		100 Hz to 40 MHz, -3 dB/50 Ω termination (1 mV/div, 2 mV/div: 100 Hz to 15 MHz, -3 dB)	

		CS-5130	CS-5135
READOUT			
Set Value		CH1/CH2 scale factor (with probe detection); V-UNCAL, ADD, INVERT A/B sweep scale factor (magnification conversion): SWEEP-UNCAL, AFTER DELAY, TRIG' D, X-Y	
Cursor Mode A mode only	$\Delta V1$	Voltage difference between ΔREF and Δ cursors on a CH1 scale factor basis	
	$\Delta V2$	Voltage difference between ΔREF and Δ cursors on a CH2 scale factor basis	
	ΔT	Time difference between ΔREF and Δ cursors on the basis of A sweep scale factor	
	$1/\Delta T$	Frequency between ΔREF and Δ cursors on the basis of A sweep scale factor	
		Ratio: Voltage and time ratio between ΔREF and Δ cursors, supposing 5-division on the CRT as 100%	
	Phase: Phase difference between ΔREF and Δ cursors, supposing 5-division on the CRT as 360°		
NOTE: The X-Y mode allows $\Delta V1$ measurement only.			
Cursor Measurement	Resolution	10 bits	
	Measurement accuracy	± 4 %	
	Measurable range	ΔV , Ratio: ± 3.6 div or more from the CRT center ΔT , $1/\Delta T$, Ratio, Phase: ± 4.6 div or more from the CRT center	
TRACE ROTATION (Electrical, adjustable from front panel)			
POWER REQUIREMENT			
Line Voltage		100 V/120 V/220 V ± 10%, 216 V–250 V	
Line Frequency		50/60 Hz	
Power Consumption		Approx. 47 W	Approx. 41 W
DIMENSIONS (W×H×D)		319 (341)×132 (145)×380 (455) mm () dimensions include protrusion from basic outline dimensions	
WEIGHT		9.0 kg	8.5 kg
ENVIRONMENTAL			
Within Specifications		10°C to 35°C, 85% max. relative humidity	
Full Operation		0°C to 40°C, 85% max. relative humidity	
ACCESSORIES SUPPLIED			
Probe		PC-33 (READOUT compatible probe) × 2	PC-30 × 2
	Attenuation	1/10	1/1, 1/10
	Input impedance	10 M Ω , 25 pF ± 10%	1 M Ω , 200 pF or less 10 M Ω , 22 pF ± 10%
Power supply cable		1	
Replacement Fuse		1 A × 2, 0.5 A × 2	
Instruction Manual		1	

* Circuit and rating are subject to change without notice due to developments in technology.

PRECAUTIONS

SAFETY

Before connecting the instrument to the power source, carefully read the following information, then verify that the power cord and power line fuse are ones for your power line. The instrument's rear panel has a fuse holder on the left of the AC inlet terminal (the fuse holder also serves as a voltage selector). The value under the triangle ▼ marked on the holder indicates the line voltage set for the instrument. If the power cord is not applied with the correct voltage, there is a danger from electric shock.

- When converting the voltage, refer to the Maintenance section.

Line voltage

This instrument operates using ac-power input voltages that 100/120/220/240 V at frequencies from 50 Hz to 60 Hz.

Power cord

The ground wire of the 3-wire ac power plug places the chassis and housing of the oscilloscope at earth ground. Do not attempt to defeat the ground wire connection or float the oscilloscope; to do so may pose a great safety hazard. The appropriate power cord is supplied by an option that is specified when the instrument is ordered.

The optional power cords are shown as follows in Fig. 1.

Line fuse

The fuse holder is located on the rear panel and contains the line fuse. Verify that the proper fuse is installed by replacing the line fuse.

EQUIPMENT PROTECTION

1. Never allow a small spot of high brilliance to remain stationary on the screen for more than a few seconds. The screen may become permanently burned. A spot will occur only when the scope is set up for X-Y operation and no signal is applied. Either reduce the intensity so the spot is barely visible, switch back to normal sweep operation when no signal is applied, or set up the scope for spot blanking.
2. Never cover the ventilating holes on the top of the oscilloscope, as this will increase the operating temperature inside the case.
3. Never apply more than the maximum rating to the oscilloscope inputs.

⚠ CH1, CH2 INPUT jacks: 500 V_{p-p} or 250 V (DC+AC peak)

EXT TRIG INPUT jack: 50 V (DC+AC peak)

Z axis INPUT jack: 50 V (DC+AC peak)

Never apply external voltage to the oscilloscope output terminals.

4. Always connect a cable from the earth ground (GND) jack of the oscilloscope to the chassis of the equipment under test. Without this caution, the entire current for the equipment under test may be drawn through the probe clip leads under certain circumstances. Such conditions could also pose a safety hazard, which the ground cable will prevent.
5. Always use the probe ground clips for best results. Do not use an external ground wire in lieu of the probe ground clips, as undesired signals may be introduced.
6. Operation adjacent to equipment which produces strong ac magnetic fields should be avoided where possible. This includes such devices as large power supplies, transformers, electric motors, etc., that are often found in an industrial environment. Strong magnetic shields can exceed the practical CRT magnetic shielding limits and result interference and distortion.
7. Probe compensation adjustment matches the probe to the input of the scope. For best results, compensation of probe should be adjusted initially, then the same probe always used with the input of scope. Probe compensation should be readjusted whenever a probe from a different scope is used. (See page 21)
8. In X-Y operation, do not pull out the PULL × 10 MAG switch. If pulled out it, noise may appear on the waveform.
9. When turning on and off the POWER switch repeatedly, keep an interval of about 5 seconds. Faster on and off operation may cause malfunction to the instrument.
10. Do not use the provided PC-33 Probe with other measuring equipment because it incorporates a terminal for READOUT detection which might damage the other equipment.







Plug configuration	Power cord and plug type	Factory installed instrument fuse	Line cord plug fuse
	North American 120 volt/60 Hz Rated 15 amp (12 amp max; NEC)	1.0 A, 250 V Fast blow 6×30 mm	None
	Universal Europe 220 volt/50 Hz Rated 16 amp	0.5 A, 250 V T. lag 5×20 mm	None
	U.K. 240 volt/50 Hz Rated 13 amp	0.5 A, 250 V Fast blow 6×30 mm	0.5 A Type C
	Australian 240 volt/50 Hz Rated 10 amp	0.5 A, 250 V Fast blow 6×30 mm	None
	North American 240 volt/60 Hz Rated 15 amp (12 amp max; NEC)	0.5 A, 250 V Fast blow 6×30 mm	None
	Switzerland 240 volt/50 Hz Rated 10 amp	0.5 A, 250 V Fast blow 6×30 mm	None

Fig. 1 Power Input Voltage Configuration

CONTROLS AND INDICATORS

FRONT PANEL

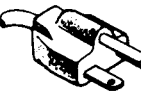
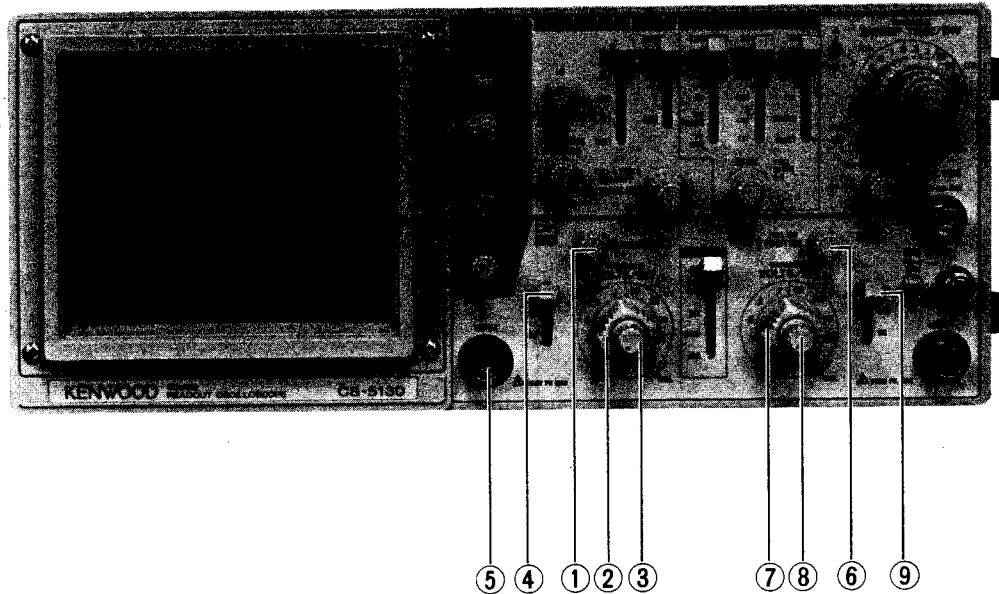

Fig. 2

- ① **CH1 \updownarrow POSITION Control**
Rotation adjusts vertical position of CH1 waveform on the screen. In X-Y operation, rotation adjusts vertical position of display.
- ② **CH1 VOLTS/DIV Control**
Vertical attenuator for channel 1. Provides step adjustment of vertical sensitivity in 1-2-5 sequence. VARIABLE control is turned to the CAL position, the calibrated vertical sensitivity is obtained. In X-Y operation, this control serves as the attenuator for Y-axis.
- ③ **CH1 VARIABLE Control**
Rotation provides fine control of channel 1 vertical sensitivity. In the fully clockwise (CAL) position, the vertical attenuator is calibrated. In X-Y operation, this control serves as the Y-axis attenuation fine adjustment.
- ④ **CH1 AC-GND-DC Switch**
This switch is the CH1 vertical axis coupling mode selector, for X-Y operation, the Y-axis coupling mode control.
AC: AC input coupling with blocking of any DC signal component.
GND: Vertical amplifier is disconnected from the input signal and connected to ground. This mode is useful in determining the zero reference.
DC: DC coupling, with both the DC and AC components of the input signal displayed on the CRT.
- ⑤ **CH1 INPUT jack**
Vertical input for channel 1 trace in normal sweep operation. Y-axis input for X-Y operation.
- ⑥ **CH2 POSITION/PULL INVERT Control**
 \updownarrow CH2 POSITION:
Rotation adjusts vertical position of channel 2 trace.
INV: Push-pull switch selects channel 2 signal inverted (PULL INV) when pulled out.
(Hereafter PULL INV is described as CH2 INV.)
- ⑦ **CH2 VOLTS/DIV Control**
Vertical attenuator for CH2. Provides the same function as VOLTS/DIV Control ② for CH1. In X-Y operation, the control serves as the X-axis attenuator.
- ⑧ **CH2 VARIABLE Control**
Rotation provides fine control of channel 2 vertical sensitivity.
Provides the same function as VARIABLE Control ③ for CH1.
In X-Y operation, this control serves for X-axis attenuation fine adjustment.
- ⑨ **CH2 AC-GND-DC Switch**
Three-position lever switch which operates as follows:
AC: Blocks DC component of channel 2 input signal.
GND: Opens signal path and grounds input to vertical amplifier. This provides a zero-signal base line, the position of which can be used as a reference when performing DC measurements.
DC: Direct input of AC and DC component of channel 2 input signal.

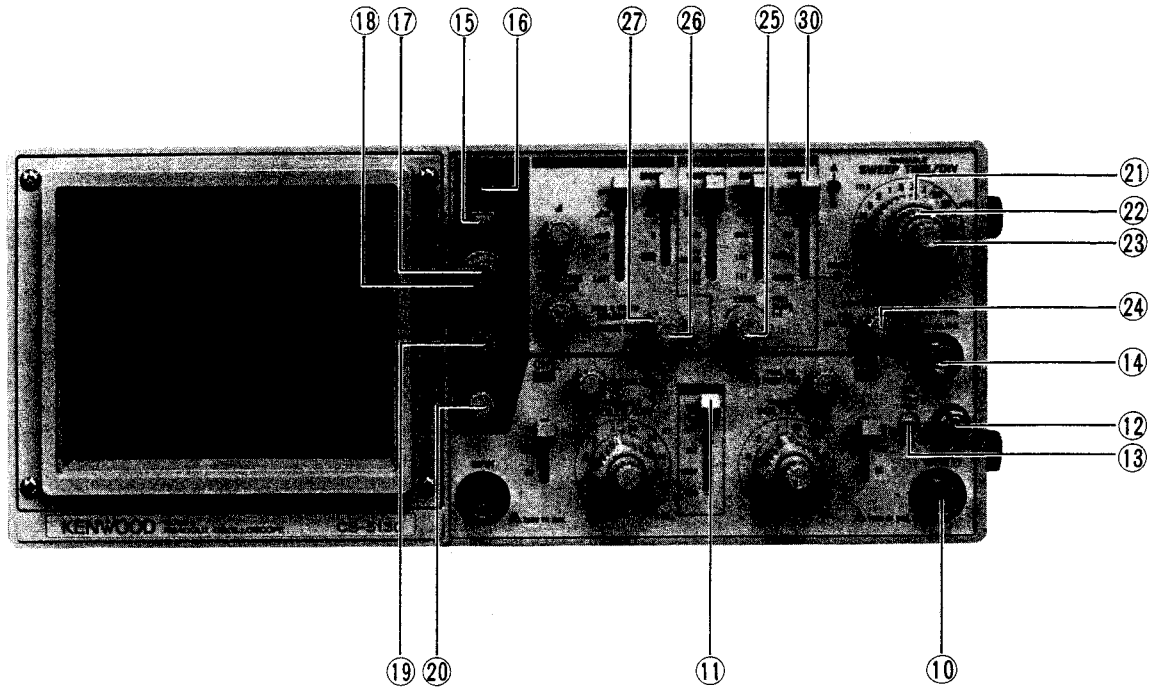

Fig. 3

- ⑩ **CH2 INPUT Jack**
Vertical input for channel 2 trace in normal sweep operation. X-axis input in X-Y operation.
- ⑪ **MODE Switch**
Selects the basic operating modes of the oscilloscope.
CH1: Only the input signal to channel 1 is displayed as a single trace.
CH2: Only the input signal to channel 2 is displayed as a single trace.
ALT: Alternate sweep is selected regardless of sweep time.
CHOP: Chop sweep is selected regardless of sweep time at approximately 300 kHz.
ADD: The waveforms from channel 1 and channel 2 inputs are added and the sum is displayed as a single trace. When the CH2 INV ⑥ button is engaged, the waveform from channel 2 is subtracted from the channel 1 waveform and the difference is displayed as a single trace.
- ⑫ **GND terminal/binding post.**
Earth and chassis ground.
- ⑬ **CAL Terminal**
Provides 1 kHz, 1 V peak-to-peak square wave signal. This is useful for probe compensation adjustment.
- ⑭ **EXT TRIG INPUT Jack**
Input terminal for external sync signal.
When SOURCE switch is selected in EXT position, the input signal at the EXT TRIG INPUT jack becomes the trigger.
- ⑮ **POWER Switch**
A press of this switch turns the power ON.
- ⑯ **POWER Indicator**
Lights when the POWER switch is pressed.
- ⑰ **INTEN (REAL) Control**
Controller for adjusting brightness of the real-time waveform.
- ⑱ **INTEN (READOUT) Control (CS-5130 only)**
Controller for adjusting brightness of the READOUT value.
* By turning the controller clockwise up to the very end, the READOUT value becomes brightest; turning counterclockwise turns readout function OFF and makes the value disappear.
- ⑲ **FOCUS/PULL ASTIG Control**
FOCUS: Focus adjustment
ASTIG: Used to bring the waveform into the best condition with the FOCUS adjustment by adjusting trace and spot aberration. Pull the knob to make a spot circular.

- ⑳ **SCALE ILLUM/PULL TRACE ROTA Control**
SCALE ILLUM: Brightness adjustment of the scale of the CRT. For photographing, rotate the knob to adjust brightness to prevent halation caused by too bright illumination.
TRACE ROTA: Tilt adjustment of the horizontal bright line in the case where geomagnetism influences the bright line to tilt.
- ㉑ **A SWEEP TIME/DIV Control**
Range select dial of 19 ranges from 0.2 μ s/div to 0.5 s/div.
To calibrate the set value, rotate the SWEEP VARIABLE controller ㉓ clockwise up to the CAL position.
- ㉒ **B SWEEP TIME/DIV Control**
Range select dial of 17 ranges from 50 ms/div to 0.2 μ s/div. Set this dial to a value same as the A SWEEP TIME/DIV ㉑ or higher than it.
- ㉓ **A SWEEP VARIABLE Control**
Fine sweep time adjustment. In the fully clockwise (CAL) position, the sweep time is calibrated.
- ㉔ **◀ ▶ POSITION/PULL \times 10 MAG Control**
Horizontal position controller, which provides horizontal shift of waveform. By pulling the knob, the sweep time is quickened ten times.
In the X-Y operation, rotation adjusts horizontal position of display.
NOTE: In X-Y operation, keep this knob pressed (normal sweep mode).
- ㉕ **LEVEL/PULL SLOPE (-) Control**
LEVEL: Trigger level adjustment determines point on triggering waveform where A sweep triggered.
PULL SLOPE (-) Switch:
Two-position push-pull switch. Pulled out position selects negative going (-) slope and pushed in position selects positivegoing (+) slope as triggering point for A sweep.
- ㉖ **HOLD OFF/PULL B TRIG'D Control**
HOLD OFF:
Adjusts holdoff (trigger inhibit period beyond sweep duration). Clockwise rotation from the NORM position increases holdoff time, up to 10 times at the MAX. position (fully clockwise).
PULL B TRIG'D:
Pulling out the knob activates B TRIG'D function. B sweep starts from the sweep start point at the trigger level after delay time set with the A SWEEP TIME/DIV and Δ REF/DELAY TIME POSITION ㉗ (DELAY TIME POSITION only on the CS-5135) has passed. The trigger signal for A sweep is used as the trigger signal for B sweep. With this knob depressed, B sweep starts after delay time set with the A SWEEP TIME/DIV and Δ REF/DELAY TIME POSITION has passed.
- ㉗ **TRACE SEPARATION Control**
Adjusts vertical separation between A sweep and B sweep (control has effect only in the ALT of HORIZ. MODE).
Clockwise rotation increases separation; B sweep moves down with respect to A sweep up to 4 divisions.
- ㉘ **COUPLING Switch**
Selects coupling for sync trigger signal.
AC: Trigger is AC coupled. Blocks DC component of input signal; most commonly used position.
HF_{REJ}: Sync signal is DC coupled through a low-pass filter to eliminate high frequency components for stable triggering of low frequency signals.
DC: The sync signal is DC coupled for sync which includes the effects of DC components.
TV FRAME:
Vertical sync pulses of a composite video signal are selected for triggering.
TV LINE: Horizontal sync pulses of a composite video signal are selected for triggering.
- ㉙ **SOURCE Switch**
Sweep trigger source select switch.
VERT MODE: (Hereinafter referred to as V.MODE).
The sweep trigger source is selected with the MODE selector for the vertical operation (Y-axis). When the vertical MODE selector is set to CH1, the channel-1 signal is used as a trigger source. When it is set to CH2, the channel-2 signal is used as a trigger source. When set to ALT, both the channel-1 and channel-2 signals are used alternately. When set to CHOP or ADD, the channel-1 signal is used as a trigger source.
CH1: Channel 1 signal is used as a trigger source.
CH2: Channel 2 signal is used as a trigger source.
LINE: Sweep is triggered by line voltage (50/60 Hz).
NOTE: When the COUPLING switch is set to other than AC position, the synchronization cannot be carried out. Be sure to set the COUPLING switch to AC position.
EXT: Sweep is triggered by signal applied to EXT TRIG input jack ㉚.
- ㉚ **TRIGGERING MODE (Trig MODE) Control**
Selects triggering mode.
AUTO: Triggered sweep operation when trigger signal is present, automatically generates sweep (free runs) in absence of trigger signal.
NORM: Normal triggered sweep operation. No trace is presented when a proper trigger signal is not applied.
X-Y: X-Y operation. Channel 1 input signal produces vertical deflection (Y-axis). Channel 2 input signal produces horizontal deflection (X-axis).
This operates regardless vertical MODE selection.

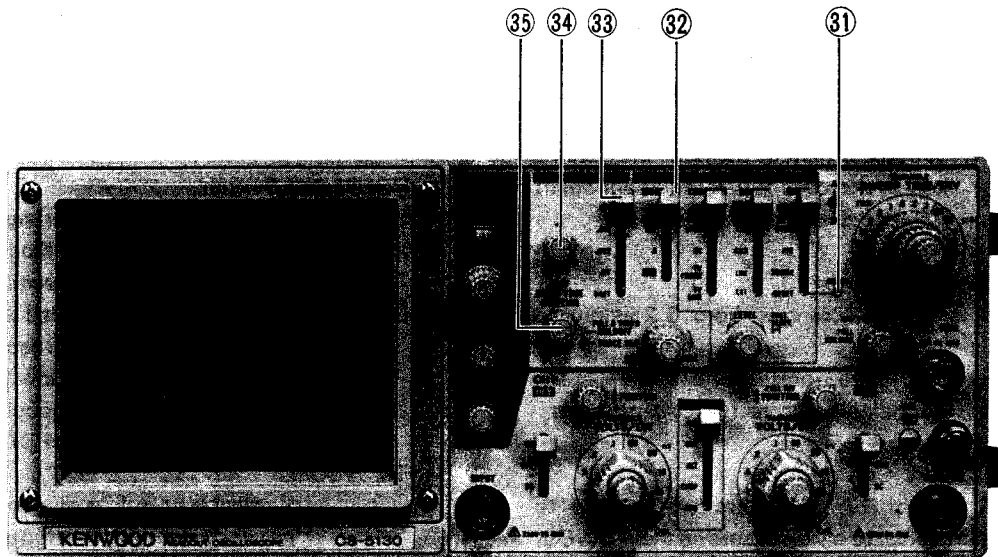

Fig. 4

SINGLE: Single-sweep mode

NOTE: Dual-trace single-sweep observation is not possible if the vertical operation MODE is set to ALT. Be sure to set the MODE to CHOP.

RESET: Reset mode of single-sweep operation. When reset, the switch returns to the SINGLE position, with the READY LED ① lighting until completion of sweep.

① **READY Indicator**

When reset in single-sweep operation, this lamp lights and remains lit until the sweep operation is completed.

② **HORIZ MODE (HORIZONTAL MODE) Switch**

Used to select the horizontal display mode.

A: Only A sweep is operative, with the B sweep dormant.

ALT: A sweep alternates with the B sweep. For this mode of operation, the B sweep appears as an intensified section on the A sweep.

B: Only delayed B sweep is operative.

X-Y: Channel 1 becomes the Y-axis and channel 2 becomes the X-axis for X-Y operation. The setting of the vertical MODE and TRIG MODE switches have no effect.

③ **CURSORS Switch (CS-5130 only)**

Cursor measurement mode select switch.

NOTE: Cursor measurement is impossible if the HORIZ MODE selector ② is set to ALT or B.

OFF: Cursor measurement is not performed. The cursor, and cursor measurement mode and cursor measurement value are not displayed on the CRT.

$\Delta V1$: Two horizontal cursor lines are displayed on the CRT, and voltage difference and voltage ratio between them are displayed in the upper right on the CRT posterior to the cursor measurement mode display.

Setting the CH1 VARIABLE controller ④ to the CAL position causes voltage difference measurement, and a value calculated in accordance with setting of the CH1 VOLTS/DIV control ② is displayed posterior to $\Delta V1$.

Setting the CH1 VARIABLE controller ④ to the UNCAL position causes voltage ratio measurement, and a value calculated assuming that 5-division as 100% is displayed posterior to the RATIO.

When the Δ cursor is below the Δ REF cursor, a negative value is displayed.

NOTE: Setting of the MODE select switch ① to the CH2 position causes $\Delta V2$ mode cursor measurement.

ΔV2: Two horizontal cursor lines are displayed on the CRT, and voltage difference and voltage ratio between them are displayed in the upper right on the CRT posterior to the cursor measurement mode display.

Setting the CH2 VARIABLE controller ⑧ to the CAL position causes voltage difference measurement, and a value calculated in accordance with setting of the CH2 VOLTS/DIV control ⑦ is displayed posterior to ΔV2.

Setting the CH2 VARIABLE controller ⑧ to the UNCAL position causes voltage ratio measurement, and a value calculated on the basis of 5-division as 100% is displayed posterior to the RATIO.

When the Δ cursor is below the ΔREF cursor, a minus value is displayed.

NOTE: Setting of the MODE select switch ⑪ to the CH1 position causes ΔV1 mode cursor measurement.

Setting of the HORIZ MODE select switch ⑳ to the X-Y position disables ΔV2 mode measurement.

ΔT: Two vertical cursor lines are displayed on the CRT, and time difference and time ratio between them are displayed in the upper right on the CRT posterior to the cursor measurement mode display.

Setting the SWEEP VARIABLE controller ⑳ to the CAL position causes time difference measurement, and a value calculated in accordance with setting of the A SWEEP TIME/DIV control ㉑ is displayed posterior to ΔT.

Setting the SWEEP VARIABLE controller ⑳ to the UNCAL position causes time ratio measurement, and a value calculated assuming that 5-division as 100% is displayed posterior to the RATIO.

When the Δ cursor is on the left of the Δ REF cursor, a minus value is displayed.

NOTE: Setting of the HORIZ MODE select switch ⑳ to the X-Y position disables ΔT mode measurement.

1/ΔT: Two vertical cursor lines are displayed on the CRT, and frequency and phase difference between them are displayed in the upper right on the CRT posterior to the cursor measurement mode display.

Setting the SWEEP VARIABLE controller ⑳ to the CAL position causes frequency measurement, and a value calculated in accordance with setting of the A SWEEP TIME/DIV control ㉑ is displayed posterior to 1/ΔT.

Setting the SWEEP VARIABLE controller ⑳ to the UNCAL position causes phase difference measurement, and a value calculated assuming that 5-division as 360° is displayed posterior to the PHASE.

When the Δ cursor is on the left of the Δ REF cursor, a minus value is displayed. However, fre-

quency is displayed in an absolute value.

NOTE: Setting of the HORIZ MODE select switch ⑳ to the X-Y position disables 1/ΔT mode measurement.

⑳ **Δ Control (CS-5130 only)**

Controller for shifting the measuring cursor (rough dotted line) out of two cursor lines displayed on the CRT in the cursor measurement. By rotating the controller clockwise, the cursor line moves upward or rightward; by rotating counterclockwise, it moves downward or leftward.

㉑ **Δ REF/DELAY TIME POSITION Control (DELAY TIME POSITION only on the CS-5135)**

Controller for shifting the reference cursor (small-dotted line) out of two cursor lines displayed on the CRT in the cursor measurement. By rotating the controller clockwise, the cursor line moves upward or rightward; by rotating counterclockwise, it moves downward or leftward.

This controller is also used to set delay time of the B sweep start point from the A sweep start point, if the HORIZ MODE selector is set to ALT or B position. (DELAY TIME POSITION)

It controls delay time continuously between 0.2 and 10 times of a set value with the A SWEEP TIME/DIV controller.

CONTROLS AND INDICATORS

REAR PANEL

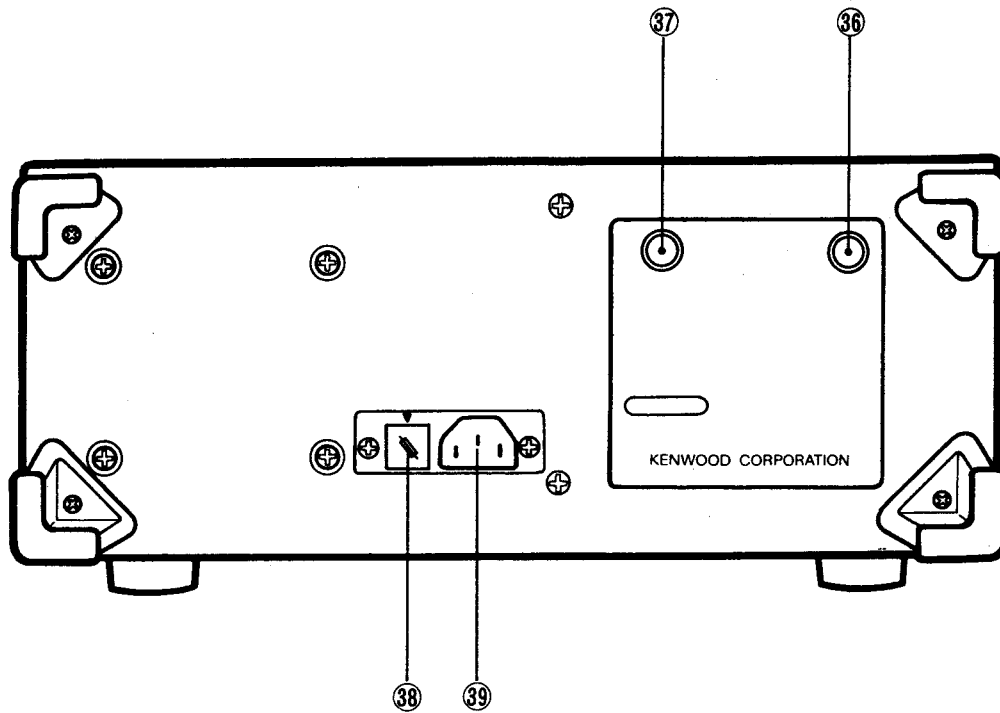

Fig. 5

- ③⑥ **Z AXIS INPUT Jack**
External intensity modulation input; TTL compatible. Positive voltage increases brightness, negative voltage decreases brightness.
- ③⑦ **CH1 OUTPUT Jack**
CH1 vertical output signal connector. AC coupled output connector. Do not connect CH1 OUTPUT to channel 2 input as cascaded operation.
- ③⑧ **Fuse Holder, Line Voltage Selector**
Contains the line fuse. Verify that the proper fuse is installed when replacing the line fuse.
100 V, 120 V.....1 A
220 V, 240 V.....0.5 A
After pulling the power cord plug from the power outlet, adjust this selector to your line voltage.
- ③⑨ **Power Input Connector**
Input terminals of power supply. Connect the AC cord provided.

DIRECTIONS FOR USE

READOUT DISPLAY (CS-5130 Only)

(1) POSITIONS OF THE DISPLAY

Displays the scale factors, cursor measurement data, etc. at the following positions on the CRT.

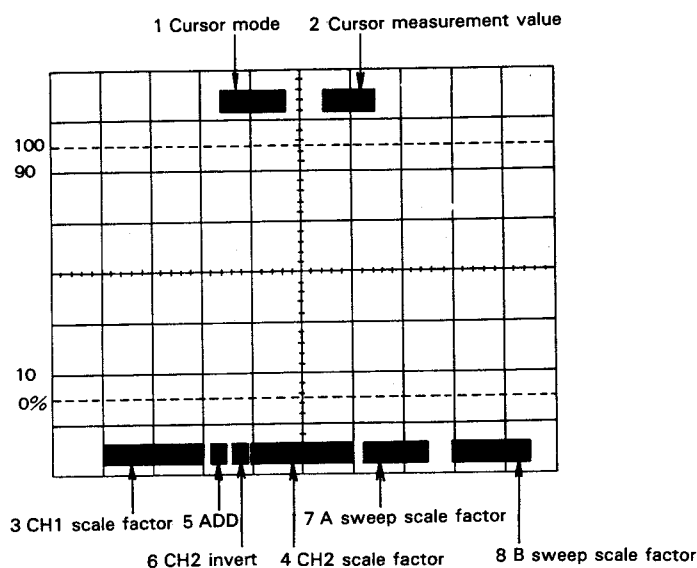

Fig. 6

(2) DISPLAY CONTENTS

1 Cursor Mode

The current setting cursor mode, which depends on the combination of the operation controls, is displayed.

ΔV_1 , ΔV_2 , ΔT , $1/\Delta T$, RATIO, PHASE

2 Cursor Measuring Data

The result measured by the two cursors is displayed. In the $1/\Delta T$ mode, when the two cursors approach each other and the measurement nears its limit, a "?" will be displayed in front of the measured data. This shows that the measured data is not available.

3 CH1 Scale Factor

Displays the CH1 vertical axis sensitivity to one division. When not in CAL mode, a ">" is displayed posterior to CH1.

NOTE: This is not displayed when the MODE switch ⑪ is set to CH2.

4 CH2 Scale Factor

Displays the CH2 vertical axis sensitivity to one division. When not in CAL mode, a ">" is displayed posterior to CH2.

NOTE: This is not displayed when the MODE switch ⑪ is set to CH1.

5 ADD

"+" is displayed when the MODE switch ⑪ is set to ADD.

6 CH2 INVERT

The inverted polarity of CH2 "↓" is displayed by controlling the ∇ POSITION/PULL INV ⑥.

7 A Sweep Scale Factor

Displays a sweep range selected with the A SWEEP TIME/DIV ⑳.

When the SWEEP VARIABLE is not set to CAL mode, a ">" is displayed posterior to A.

8 B Sweep Scale Factor

Displays a sweep range selected with the B SWEEP TIME/DIV if the HORIZ MODE ㉓ is set to ALT or B.

By pulling the \blacktriangleleft POSITION/PULL $\times 10$ MAG ㉔, $1/10$ scale factors of the A SWEEP TIME/DIV ㉑ and B SWEEP TIME/DIV ㉒ are displayed. If the HORIZ MODE ㉓ is set to X-Y position, "X-Y" is displayed instead of A and B sweep ranges.

9 Delay Time

The cursor mode and cursor measuring data are not displayed if the HORIZ MODE ㉓ is set to ALT or B. "DELAY" is displayed in place of the cursor mode, and a delay time is displayed in place of the cursor measuring data.

If the triggered delay (B TRIG'D) is selected, "?" is displayed posterior to DELAY.

OPERATING INSTRUCTIONS

INITIAL STARTING PROCEDURE

Prior to turning the power ON, set the switches as in the drawing below in advance. For details of switch setting,

refer to the item "Front Panel". In the case of using a probe, refer to the Operation Manual attached to the probe as well as the application example "Probe Compensation".

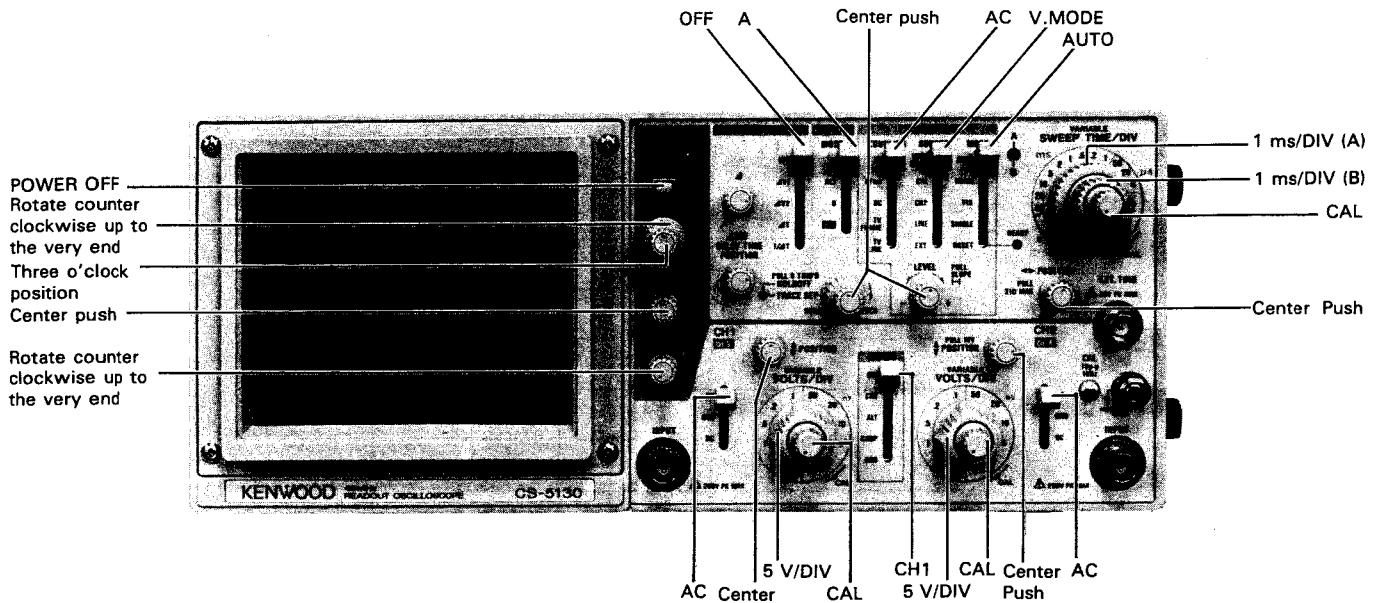

Fig. 7

[A] OPERATION AS A GENERAL-USE OSCILLOSCOPE

(1) Normal sweep display operation

1. Press the POWER switch ⑮ to supply power, and the POWER LED ⑯ lights.
2. A bright line appears in the CRT center. If it is not in the center, adjust its position to the center with the \blacktriangle POSITION controller ①. Then, adjust the brightness with the INTENSITY controller ⑰, and the focus, with the FOCUS controller ⑲ as required for easy observation.
3. Supply input signal into the CH1 INPUT jack ⑤. Rotate the VOLTS/DIV control ② to adjust waveform to appropriate dimensions.

Set the MODE select switch ⑪ to CH2. Then, supply input signal into the CH2 INPUT connector ⑫. Its waveform is displayed on the CRT in the same procedures with channel 1.

When the MODE select switch is set to ADD, the composite waveforms of CH1 and CH2 (the algebraic sum of CH1 + CH2) is displayed on the CRT. In this status, if CH2 INV is engaged by pulling out the CH2 \blacktriangle POSITION, the algebraic difference between CH1 and CH2 (CH1 - CH2) will be displayed.

The sensitivity of the ADDED waveform becomes the same as the value indicated by VOLTS/DIV provided that the same VOLTS/DIV value has been set for the waveforms of the two channels.

When the MODE select switch ⑪ is set to ALT, the channel-1 and channel-2 waveforms are displayed alternately in every sweep. Waveform of each channel is triggered independently. If the MODE select switch ⑪ is set to CHOP, channel-1 and channel-2 waveforms through chopped triggering are displayed. If the SOURCE select switch ⑳ is set to V. MODE, the channel-1 signal only

is triggered. To make the channel-2 signal triggered, set the SOURCE select switch ⑳ to CH2.

4. The display on the screen will probably be unsynchronized. Refer to TRIGGERING procedure below for adjusting synchronization and sweep speed to obtain a stable display showing the desired number of waveform.

TRIGGERING

The input signal must be properly triggered for stable waveform observation. TRIGGERING is possible the input signal INTERNALLY to create a trigger or with an EXTERNALLY provided signal of timing relationship to the observed signal, applying such a signal to the EXT. TRIG INPUT jack ⑭.

- (1) The selection of a signal that serves as the trigger signal is made using the SOURCE switch ⑳.

★ Internal Sync

When the SOURCE selector ⑳ is set to V.MODE, CH1, CH2 or LINE, the input signal is connected to the internal trigger circuit. In this position, a part of the input signal fed to the INPUT jack ⑤ or ⑩ is applied from the vertical amplifier to the trigger circuit to cause the trigger signal synchronously with the input signal to drive the sweep circuit. If the SOURCE select switch is set to V.MODE, the trigger signal is selected in compliance with the vertical MODE selector setting. (Refer to the section "CONTROLS AND INDICATORS".) Setting the vertical MODE selector to ALT causes independent trigger to the channel-1 and channel-2 signals respectively, enabling two signals with no time relationship to be observed.

If the SOURCE select switch is set to CH1 or CH2, triggering is made by the channel-1 and channel-2 signals respectively, regardless of MODE ⑪ setting. Setting the SOURCE select switch to LINE causes synchronization with commercial power frequency.

★ External Sync

When the SOURCE selection is in EXT, the input signal at the EXT TRIG INPUT (14) jack becomes the trigger. This signal must have a time or frequency relationship to the signal being observed to synchronize the display. External sync is preferred for waveform observation in many applications. For example, Fig. 8 shows that the sweep circuit is driven by the gate signal when the gate signal in the burst signal is applied to the EXT. TRIG INPUT jack.

Shows the input/output signals, where the burst signal generated from the signal is applied to the instrument under test. Thus, accurate triggering can be achieved without regard to the input signal fed to the INPUT (5) or (10) jack so that no further triggering is required even when the input signal is varied.

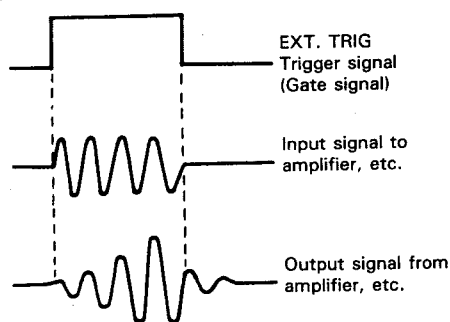

Fig. 8

- (2) After the SOURCE has been set, the trigger point can be set by rotating LEVEL/SLOPE control (25).

AC:

The trigger signal is capacitively coupled, so its DC component is cut, giving a stable trigger which is not affected by the DC component. With this advantage, this position of the coupling switch is conveniently selected for ordinary applications. However, if the trigger signal is lower than 10 Hz, the trigger signal level becomes attenuated, resulting in difficulty in triggering.

HF REJ:

The trigger signal is supplied through a low-pass filter to eliminate the high-frequency component (higher than 10 kHz), giving a stable triggering with low-frequency component. When high-frequency noise is superimposed over the trigger signal as shown in Fig. 9, the high-frequency noise is cut to provide a stable trigger.

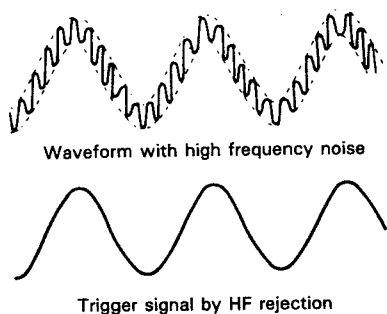

Fig. 9

DC:

Permits triggering from dc to over 60 MHz. Couples dc component of sync trigger signal. Useful for triggering from very low frequency signals (below 10 Hz) or ramp waveforms with slow repeating dc.

- (3) Setting of coupling switch (28).

★ Triggering Level

Trigger point on waveform is adjusted by the LEVEL/PULL (25) control. Fig. 10 shows the relationship between the SLOPE and LEVEL of the trigger point. Triggering level can be adjusted as necessary.

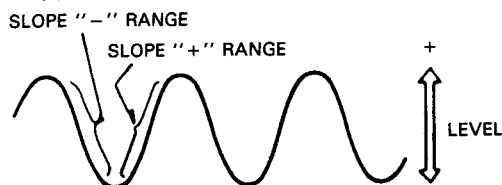

Fig. 10

★ Auto Trigger

When the TRIG MODE (30) selection is in AUTO, the sweep circuit becomes free-running as long as there is no trigger signal, permitting a check of GND level. When a trigger signal is present, the trigger point can be determined by the LEVEL control for observation as in the normal trigger signal. When the trigger level exceeds the trigger signal, the trigger circuit also becomes free-running where the waveform starts running. When the TRIG MODE is set to NORM and/or, when the trigger signal is absent or the triggering level exceeds the signal there is no sweep.

★ Fix

When the TRIG MODE (30) is set to FIX, triggering is always effected in the center of the waveform, eliminating the need for adjusting the triggering level. As shown in Fig. 11-(a) or (b), when the TRIG MODE is set to NORM and the triggering level is adjusted to either side of the signal, the trigger point is deviated as the input signal becomes small which, in turn, stops the sweep operation. By setting the TRIG MODE to FIX, the triggering level is automatically adjusted to the approximate center of the waveform and the signal is synchronized regardless of the position of LEVEL control as shown in Fig. 11-(c). When the input signal is suddenly changed from a square waveform to a pulse waveform, the trigger point is shifted extremely toward the " - " side of the waveform unless the triggering level is readjusted as shown in Fig. 12-(a).

See Fig 12-(a)-(2). Also, if the trigger point has been set to the " - " of squarewave (Fig 12-(b)-(1)) and the input signal is changed to a pluse signal, the trigger point is deviated and the sweep stops. When this happens, set the TRIG MODE to FIX and the triggering is effected in the approximate center of the waveform, making it possible to observe a stabilized waveform. (Fig 12-(c))

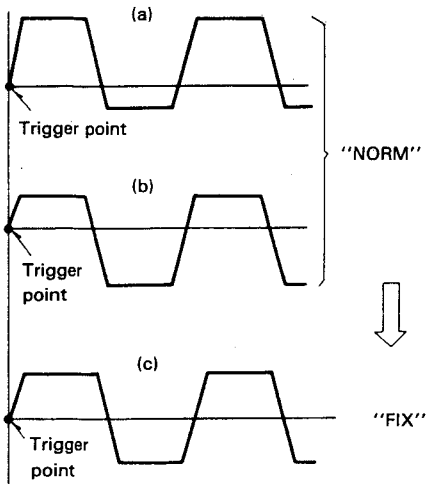
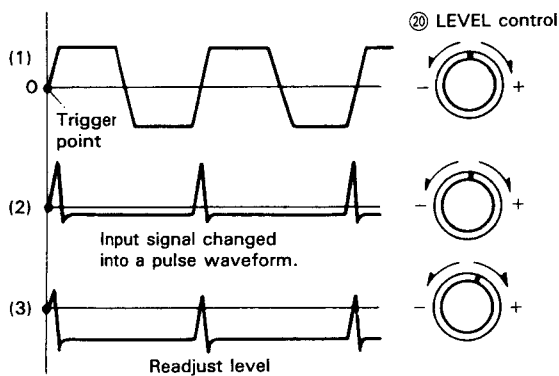
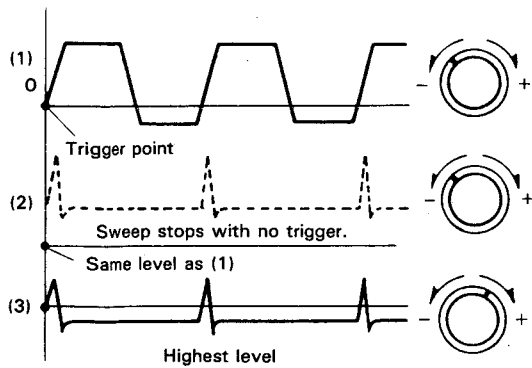

Fig. 11



(a) When the trigger level is set around the center of the waveform.



(b) When the trigger level is set to the "-" side of the waveform (Mode switch set to "NORM")

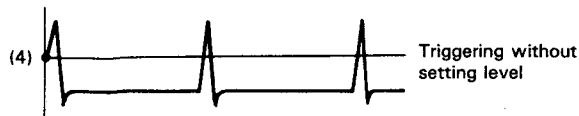

(c) Mode switch set to "FIX".

Fig. 12

5. Adjust the A SWEEP/TIME DIV control (21) to obtain an appropriate display. Now a normal sweep display is obtained.

(2) MAGNIFIED SWEEP OPERATION

Since merely shortening the sweep time to magnify a portion of an observed waveform can result in the desired portion disappearing off the screen, such magnified display should be performed using the MAGNIFIED SWEEP.

Using the ◀▶ POSITION (24) control, adjust the desired portion of waveform to the CRT. Pull the PULL × 10 MAG (24) control to magnify the display 10 times. For this type of display the sweep time is the SWEEP TIME/DIV setting divided by 10.

(3) ALTERNATE SWEEP OPERATION

A sweep and B delayed sweep are usable in an alternating fashion making it possible to observe both the normal and magnified waveform simultaneously.

Procedure:

1. Set the HORIZ MODE to A and adjust for a normal waveform display.
2. Depress the HOLD OFF control (26) (AFTER DELAY) and set the HORIZ MODE to ALT. Adjust TRACE SEPARATION (27) for easy observation of both the A and B traces. The upper trace is the non-magnified portion of the waveform with the magnified portion super-imposed as an intensified section. The lower waveform is the intensified portion displayed magnified.
3. The Δ REF/DELAY TIME POSITION (35) control can be used to continuously slide the magnified portion of the waveform across the A sweep period to allow magnification of precisely the desired portion of waveform.
4. Set the HORIZ MODE to B to display the INT intensified portion as a magnified B sweep. (Fig. 14)
5. For Starts AFTER DELAY operation, apparent jitter increases as magnification increases. To obtain a jitter free display pull the HOLD OFF control out. In this "Triggerable After Delay" mode the A trigger signal selected by the SOURCE switch (29) becomes the B trigger source.

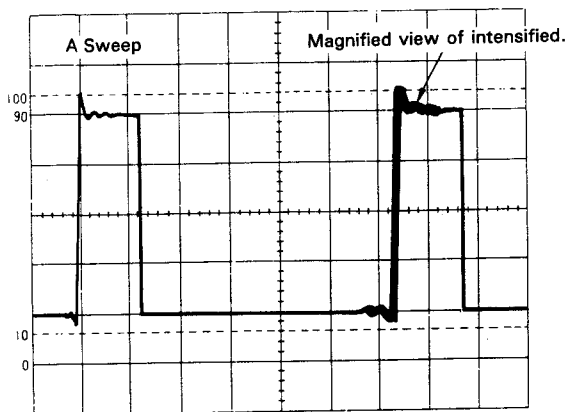

Fig. 13

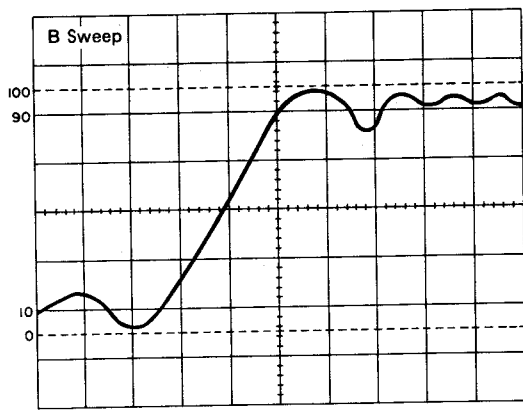

Fig. 14 Magnified view of intensified zone above

Note that for this type of operation both the DELAY TIME POSITION and TRIG LEVEL affect the start of the B sweep so that the delay time is used as a reference point. (Fig. 15)

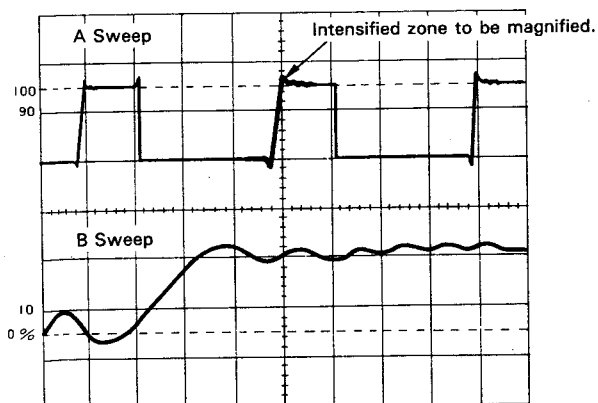

Fig. 15

(4) X-Y OPERATION

For some measurements, an external horizontal deflection signal is required. This is also referred to as an X-Y measurement, where the Y input provides vertical deflection and X input provides horizontal deflection.

X-Y operation permits the oscilloscope to perform many types of measurements not possible with conventional sweep operation. The CRT display becomes an electronic graph of two instantaneous voltages. The display may be a direct comparison of two voltages such as during phase measurement, or frequency measurement with Lissajous waveforms.

To use an external horizontal input, use the following procedure;

1. Set the HORIZ MODE switch to X-Y the position.
2. Use the channel 1 probe for the vertical input and the channel 2 probe for the horizontal input.
3. Adjust the amount of horizontal deflection with the CH2 VOLTS/DIV and VARIABLE controls.
4. The CH2 (vertical) POSITION (6) control now serves as the horizontal position control, and the ◀▶ POSITION (24) control is disabled.
5. All sync controls are disconnected and have no effect.

(5) VIDEO SIGNAL OBSERVATION

The TV FRAME/LINE switch permits selection of vertical or horizontal sync pulse for sweep triggering when viewing composite video waveforms. In the LINE position, horizontal sync pulses are selected as triggers to permit viewing of horizontal line of video. In the FRAME position, vertical sync pulses are selected as triggers to permit viewing of vertical fields and frames of video. When observing the video waveforms, stable display is obtained on the screen regardless the TRIG LEVEL (25) control if the TRIG MODE (30) switch to FIX.

At most points of measurement, a composite video signal is of the (-) polarity, that is, the sync pulses are negative and the video is positive. In this case, use " - " SLOPE. If the waveform is taken at a circuit point where the video waveform is inverted, the sync pulses are positive and the video is negative. In this case, use " + " SLOPE.

(6) SINGLE SWEEP OPERATION

This mode of display is useful for looking at non-synchronous or one time events.

Procedure:

1. Set the TRIG MODE ⑩ to either AUTO or NORM. Apply a signal of approximately the same amplitude and frequency as the signal that is to be observed as the trigger signal and set the trigger level.
2. Set TRIG MODE to RESET — observe that the READY indicator LED lights to indicate the reset condition. This LED goes out when the sweep period is completed.
3. After the above set-up is completed the scope is ready to operate in the SINGLE sweep mode of operation after resetting the instrument using the RESET switch. Input of the trigger signal results in one and only one sweep and READY indicator LED goes out.

NOTE:

With the HORIZ MODE set to ALT the simultaneous observation of the A sweep and B sweep waveforms at SINGLE sweep mode is not possible. Also for ALT (vertical MODE) mode operation simultaneous observation is not possible. Set the unit to the CHOP mode in this case.

- $\Delta V2$: Set the CURSORS select switch ⑩ to $\Delta V2$, voltage difference in accordance with the CH2 range setting is displayed in the upper right on the CRT similarly with the above $\Delta V1$.
- ΔT : Set the CURSORS select switch ⑩ to ΔT , and two vertical cursor lines are displayed on the CRT and time difference between the cursor lines calculated based on the A sweep scale factor displayed in the lower right is displayed in the upper right. By setting the SWEEP VARIABLE controller ③ to the UNCAL position, time ratio is displayed.
- $1/\Delta T$: Set the CURSORS select switch ⑩ to $1/\Delta T$, and two vertical cursor lines are displayed on the CRT and frequency between the cursor lines calculated based on the A sweep scale factor displayed in the lower right is displayed in the upper right. By setting the SWEEP VARIABLE controller ③ to the UNCAL position, phase difference is displayed.

[B] READOUT OPERATION (CS-5130 only)

1 CRT surface readout

By rotating the INTEN (READOUT) controller ⑩ clockwise up to the very end, characters are displayed on the CRT. Adjust the brightness as necessity requires. The CH1 and CH2 scale factors are displayed in the lower part of the CRT in accordance with setting of the MODE select switch ⑪. The sweep scale factor is displayed in the lower right part. By pulling the ◀ ▶ POSITION/PULL $\times 10$ MAG switch ⑭, a tenth scale factor of the A and B SWEEP TIME/DIV control ⑰ ⑱ is displayed.

NOTE: When the readout values are displayed, brilliance modulation may influence the real-time waveform in some cases. In such a case, rotate the INTEN (READOUT) control ⑩ fully counterclockwise. The readout function will be turned OFF, and the brilliance modulation on the real-time waveform will disappear.

2 Cursor measurement

$\Delta V1$: Set the MODE select switch ⑪ to ALT and the CURSORS select switch ⑩ to $\Delta V1$, and two horizontal cursor lines are displayed on the CRT and voltage difference between cursor lines calculated in accordance with setting of the CH1 VOLTS/DIV control ② is displayed in the upper right on the CRT. By setting the CH1 VARIABLE controller ③ to the UNCAL position, voltage ratio is displayed.

Move the cursors to the positions to be measured with the Δ REF controller ⑮ and Δ controller ⑯.

APPLICATIONS

PROBE COMPENSATION

For accurate measurement, perform appropriate probe correction prior to measurement.

1. Connect a probe to the INPUT terminal, and set each switch so that normal sweep is displayed.
2. Connect the probe to the CAL terminal on the front panel, and adjust the SWEEP TIME/DIV switch so that several cycles of this signal are displayed.
3. Adjust compensation trimmer on probe for optimum square wave waveshape (minimum overshoot, rounding off, and tilt).

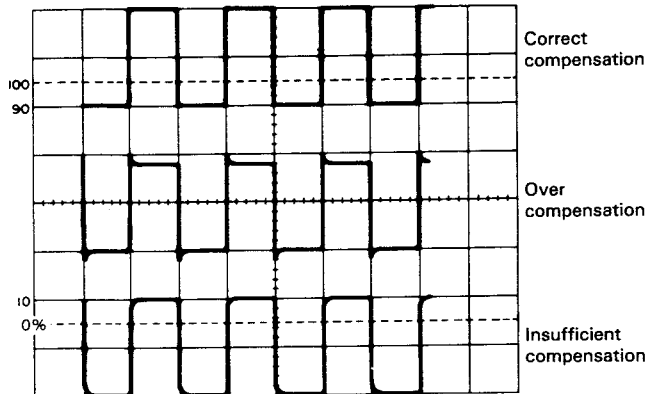

Fig. 16

TRACE ROTATION COMPENSATION

Rotation from a horizontal trace position can be the cause of measurement errors.

Adjust the controls for a single display. Set the AC-GND-DC switch to GND and TRIG MODE to AUTO. Adjust the \blacktriangleleft POSITION control such that the trace is over the center horizontal graticule line. If the trace appears to be rotated from horizontal, align it with the center graticule line using the TRACE ROTATION control located on the front panel.

1. DC VOLTAGE MEASUREMENT

Two types of measurement methods are provided; ordinary measurement and cursor measurement.

(1) Ordinary Measurement

To measure waveform DC level, carry out the following operations:

1. Connect the signal to be measured to the INPUT jack. For the channel which is selected by the vertical MODE switch, set the AC-GND-DC switch to DC and adjust the controls for normal sweep. Then adjust the VOLTS/DIV and SWEEP TIME/DIV controls to the optimum settings for measurement of the waveform. The VARIABLE switch should be set to CAL.
2. Set the TRIG MODE switch to AUTO and AC-GND-DC switch to GND. The trace displayed at this time is the GND level (reference line). Using the \blacktriangleleft POSITION control, adjust the trace position to the desired reference level position, making sure not to disturb this setting once made.

3. Set the AC-GND-DC switch to the DC position to observe the input waveform, including its DC component. If an appropriate reference level or VOLTS/DIV setting was not made, the waveform may not be visible on the CRT screen at this point. If so, reset VOLTS/DIV and/or the \blacktriangleleft POSITION control.
4. Use the \blacktriangleleft POSITION control to bring the portion of the waveform to be measured to the center vertical graduation line of the CRT screen.
5. Measure the vertical distance from the reference level to the point to be measured, (the reference level can be rechecked by setting the AC-GND-DC switch again to GND).

To obtain the real voltage, multiply the vertical distance value by the VOLTS/DIV indication value. When a 10:1 probe is used, further multiply the value by 10. Voltages above and below the reference level are positive and negative values respectively.

- ① When a 10:1 probe is used:
DC level = Vertical distance (div) \times VOLTS/DIV setting \times 10
- ② With direct measurement
DC level = Vertical distance in divisions \times (VOLTS/DIV setting) \times (probe attenuation ratio).

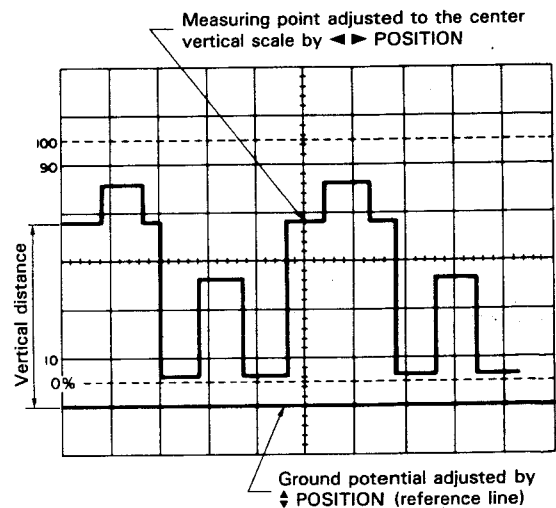

Fig. 17

[EXAMPLE]

For the example, the point being measured is 3.8 divisions from the reference level (ground potential).

If the VOLTS/DIV was set to 0.2 V and a 10:1 probe was used. (See Fig. 17)

Substituting the given values:

$$\text{DC level} = 3.8 \text{ (div)} \times 0.2 \text{ (V)} \times 10 = 7.6 \text{ V}$$

(2) CURSOR measurement

- 1) Make the GND luminescent line be displayed by means of ordinary procedures 1) and 2).
- 2) Set the cursor mode to $\Delta V1$ or $\Delta V2$ in accordance with the channel to be used.
- 3) Adjust the Δ REF cursor (reference line) to the GND luminescent line.
- 4) Set the AC-GND-DC switch to DC.
- 5) Adjust the Δ cursor to a point to be measured.
- 6) Measured value is displayed in the upper right part on the screen.

If the attached probe PC-33 is used, measured value including the attenuation ratio is displayed. If a probe incompatible with the readout function is used, measured value is multiplied by the attenuation ratio. Lowering of the Δ cursor below the Δ REF cursor indicates negative voltage, displaying "--".

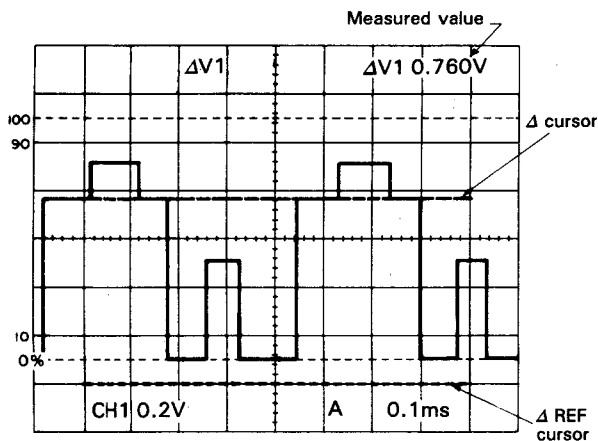

Fig. 18

2. MEASUREMENT OF THE VOLTAGE BETWEEN TWO POINTS ON A WAVEFORM

(1) Ordinary measurement

This technique can be used to measure peak-to-peak voltages.

1. Apply the signal to be measured to the INPUT jack. Set the vertical MODE to the channel to be used. Set the vertical MODE to the channel to be used. Set the AC-GND-DC to AC, adjusting VOLTS/DIV and SWEEP TIME/DIV for a normal display. Set the VARIABLE control to CAL position.
2. Using the \updownarrow POSITION control, adjust the waveform position such that one of the two points falls on a CRT graduation line and that the other is visible on the display screen.
3. Using the $\leftarrow \rightarrow$ POSITION control, adjust the second point to coincide with the center vertical graduation line.
4. Measure the vertical distance between the two points and multiply this by the setting of the VOLTS/DIV control. When a 10:1 probe is used, further multiply the value by 10.

- ① When a 10:1 probe is used.
Volts peak-to-peak
= Vertical distance (div) \times (VOLTS/DIV setting) \times 10
- ② With direct measurement
Voltage between 2 points = Vertical distance (div) \times 2 points.

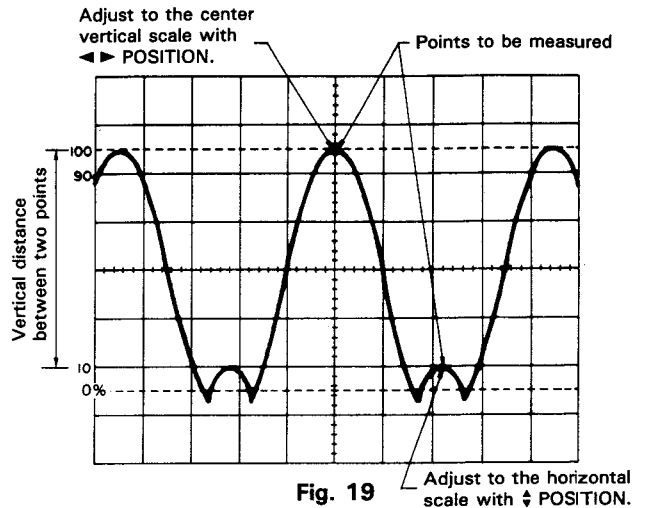

Fig. 19

[EXAMPLE]

For the example, the two points are separated by 4.5 divisions vertically. Set the VOLTS/DIV setting be 0.2 V/div and the probe attenuation be 10:1. (See Fig. 19)

Substituting the given value:

$$\text{Voltage between two points} = 4.5 \text{ (div)} \times 0.2 \text{ (V/div)} \times 10 = 9.0\text{V}$$

(2) Cursor measurement (CS-5130 only)

- 1) Make waveform to be observed be displayed on the screen in ordinary procedure 1).
- 2) Set the cursor mode to $\Delta V1$ or $\Delta V2$ in accordance with the channel to be used.
- 3) Adjust the Δ REF cursor to a lower point to be measured, and the Δ cursor to another point.
- 4) Measured value is displayed in the upper right part on the screen.

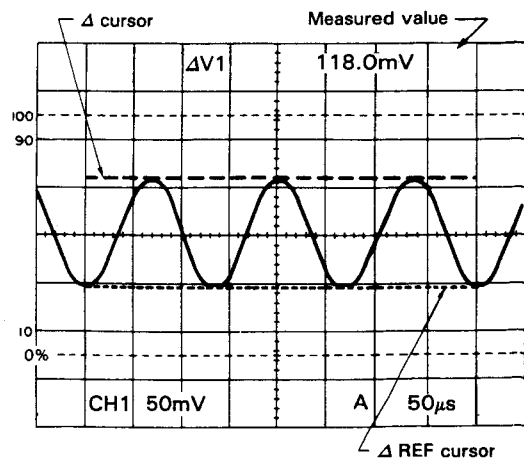

Fig. 20

3. ELIMINATION OF UNDESIRE SIGNAL COMPONENTS

The ADD feature can be conveniently used to cancel out the effect of an undesired signal component which superimposed on the signal you wish to observe.

Procedure:

1. Apply the signal containing an undesired component to the CH1 INPUT jack and the undesired signal itself alone to the CH2 INPUT jack.
2. Set the vertical MODE switch to CHOP and SOURCE switch to CH2. Verify that CH2 represents the unwanted signal in reverse polarity. Reverse the polarity by setting CH2 INV as required.
3. Set the vertical MODE to ADD, SOURCE to V. MODE and CH2 VOLTS/DIV and VARIABLE so that the undesired signal component is cancelled as much as possible. The remaining signal should be the signal you wish to observe alone and free of the unwanted signal.

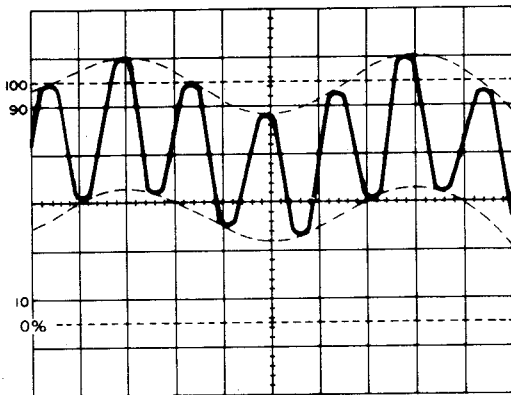

Signal containing undesired component
(Broken lines: undesired component envelope)

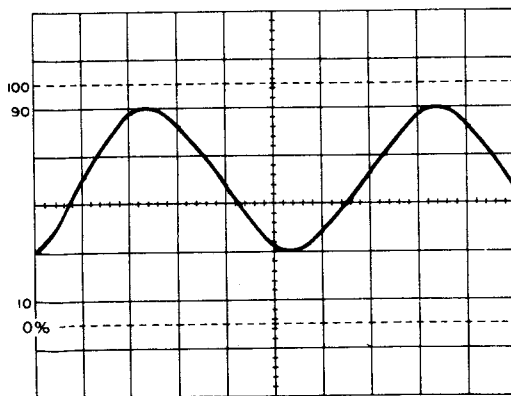

Undesired component signal

Fig. 21

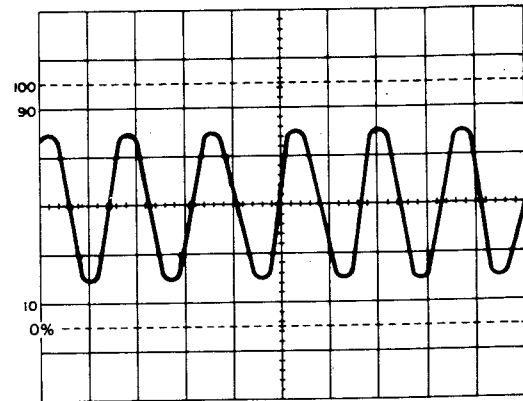

Signal without undesired component

Fig. 22

4. VOLTAGE RATIO MEASUREMENT USING CURSORS (CS-5130 only)

Overshoot of square waves, etc. can be measured in the following procedures:

- 1) Supply signal into the INPUT terminal. Set the V. MODE switch to the channel to be used. the AC-GND-DC selector switch to DC. and each switch so that ordinary sweep is displayed. Then adjust the VOLTS/DIV and SWEEP TIME/DIV for easy waveform observation.
- 2) Turn on the VERTICAL VARIABLE switch to adjust the amplitude to 5 div points (0% and 100%) on the screen as necessity requires with the \updownarrow POSITION switches.
NOTE: When the SWEEP TIME VARIABLE switch is set to UNCAL, the unit is set to RATIO measurement mode.
- 3) Set the cursor mode to $\Delta V1$ or $\Delta V2$ in accordance with the channel to be used.
- 4) Adjust the Δ REF cursor to 100%.
- 5) Adjust the Δ cursor to a point overshoot at which is to be measured.
- 6) Overshoot voltage ratio with respect to the 5 div (100%) point is displayed in the upper right part on the screen.

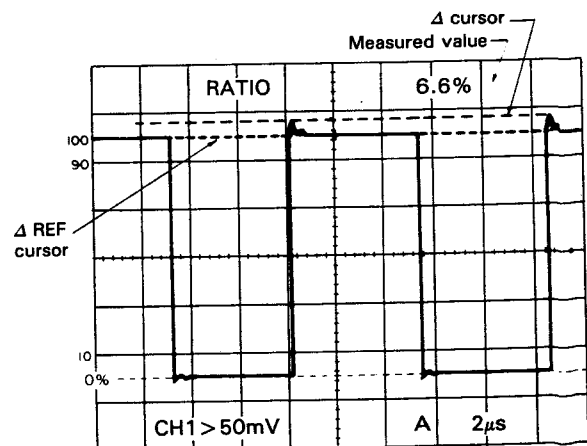

Fig. 23

5. TIME MEASUREMENTS

(1) Ordinary measurement

Time between two points on a wave can be measured from the SWEEP TIME/DIV value and horizontal distance between two points.

Procedure:

1. Apply the signal to be measured to the INPUT jack. Set the vertical MODE to the channel to be used. Set the AC-GND-DC to DC, adjusting VOLTS/DIV and SWEEP TIME/DIV for a normal display. Set the VARIABLE control to CAL position.
2. ◀▶ POSITION control to set this point at the intersection of any vertical graduation line. Using the ⬆ POSITION control, set one of the points to be used as a reference to coincide with the horizontal centerline.
3. Measure the horizontal distance between the two points. Multiply this by the setting of the SWEEP TIME/DIV control to obtain the time between the two points. If horizontal "×10 MAG" is used, multiply this further by 1/10.

Using the formula:

Time = Horizontal distance (div) × (SWEEP TIME/DIV setting) × "×10 MAG" value⁻¹ (1/10)

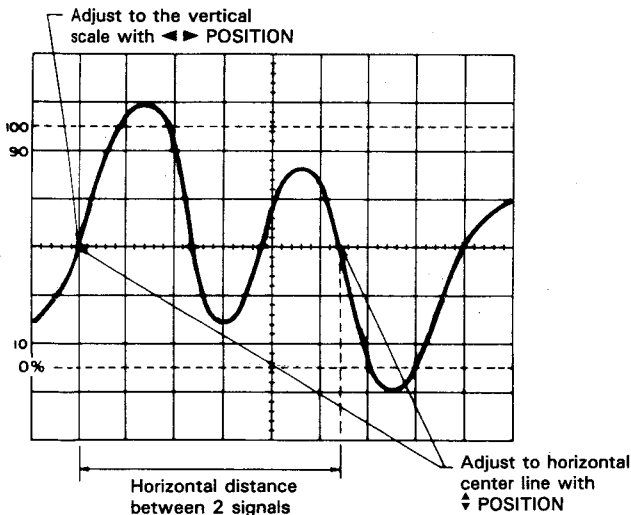

Fig. 24

[EXAMPLE]

For the example, the horizontal distance between the two points is 5.4 divisions.

If the SWEEP TIME/DIV is 0.2 ms/div we calculate. (See Fig. 24)

Substituting the given value:

$$\text{Time} = 5.4 (\text{div}) \times 0.2 (\text{ms/div}) = 1.08 \text{ ms}$$

(2) Cursor measurement (CS-5130 only)

1. In the same way as the ordinary measurement, adjust the waveform to be measured to an easy-to-observe point.
2. Set the cursor mode to Δ T.
3. Adjust the Δ REF cursor to the left of the two point to be measured, and the Δ cursor to the right.
4. Measured value is displayed in the upper right part on the screen posterior to Δ T.

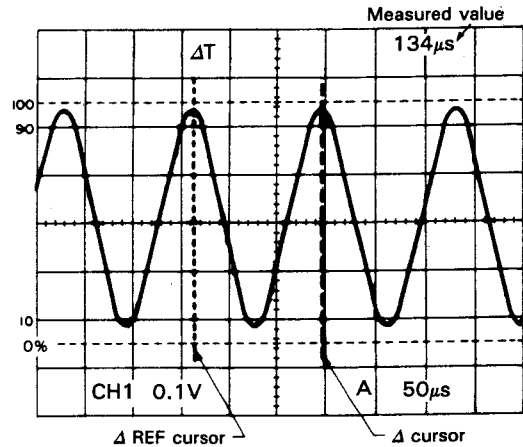

Fig. 25

6. TIME DIFFERENCE MEASUREMENTS

(1) Ordinary measurement

Time difference between two synchronized signals can be measured as follows:

Procedure:

1. Apply the two signals to CH1 and CH2 INPUT jacks. Setting the vertical MODE to either ALT or CHOP mode. Generally for low frequency signals CHOP is chosen with ALT used for high frequency signals.
2. Select the faster of the two signals as the SOURCE and use the VOLTS/DIV and SWEEP TIME/DIV to obtain an easily observed display. Set the VARIABLE control to CAL position.
3. Using the ⬆ POSITION control set the waveforms to the center of the CRT display and use the ◀▶ POSITION control to set the reference signal to be coincident with a vertical graduation line.
4. Measure the horizontal distance between the two signals and multiply this distance in divisions by the SWEEP TIME/DIV setting. If "×10 MAG" is being used multiply this again by 1/10.

Using the formula:

Time = Horizontal distance (div) × (SWEEP TIME/DIV setting) × "×10 MAG" value⁻¹ (1/10)

[EXAMPLE]

For the example, when the horizontal distance between two signals is 4.4 divisions. The SWEEP TIME/DIV is 0.2 (ms/div). (See Fig. 26)

Substituting the given value:

$$\text{Time} = 4.4 (\text{div}) \times 0.2 (\text{ms/div}) = 0.88 \text{ ms}$$

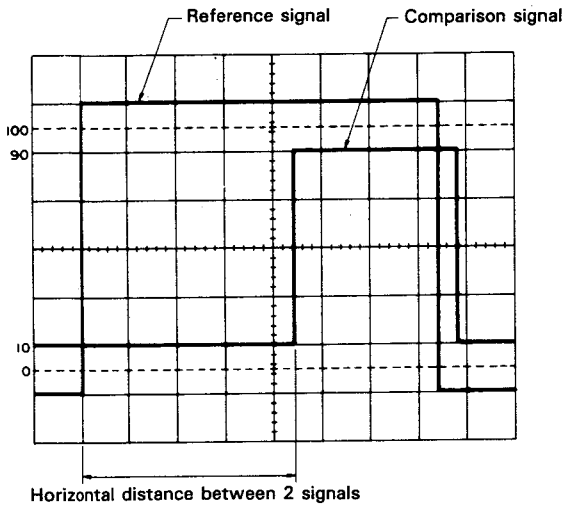

Fig. 26

(2) Cursor measurement (CS-5130 only)

1. In the same way as the ordinary measurement, adjust waveforms to be measured to an easy-to-observe position.
2. Set the cursor mode to ΔT .
3. Adjust the Δ REF cursor to the left point time difference between which is to be measured. and the Δ cursor to the right.
4. Measured value is displayed in the upper right part on the screen.

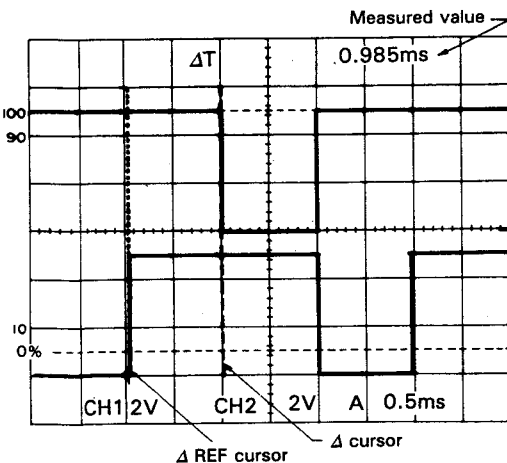

Fig. 27

7. PULSE WIDTH MEASUREMENTS

(1) Ordinary measurement

Pulse width can be measured as follows:

Procedure:

1. Apply the pulse signal to the INPUT jack. Set the vertical MODE switch to the channel to be used.
2. Use the VOLTS/DIV, VARIABLE and \updownarrow POSITION to adjust the waveform such that the pulse is easily observed and such that the center pulse width coincides with the center horizontal line on the CRT screen.
3. Set the SWEEP VARIABLE switch to CAL. Measure the horizontal distance between the intersections of the pulse waveform and CRT center horizontal line in divisions, and multiply the measured distance by the value indicated by SWEEP TIME/DIV. If the "x10MAG" mode is being used, also multiply the product by 1/10.

Using the formula:

$$\text{Pulse width} = \text{Horizontal distance (div)} \times (\text{SWEEP TIME/DIV setting}) \times \text{"xMAG 10" value}^{-1} (1/10)$$

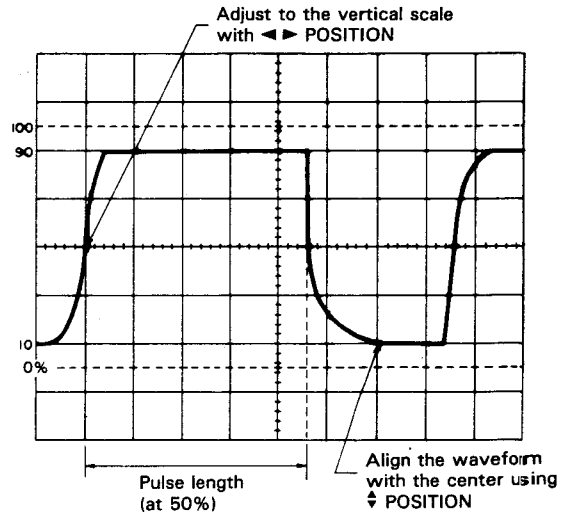

Fig. 28

[EXAMPLE]

For the example, the distance (width) at the center horizontal line is 4.6 divisions and the SWEEP TIME/DIV is 0.2 (ms/div). (See Fig. 28)

Substituting the given value:

$$\text{Pulse width} = 4.6 (\text{div}) \times 0.2 (\text{ms/div}) = 0.92 \text{ ms}$$

(2) Cursor measurement (CS-5130 only)

1. In the same way as the ordinary measurement, adjust waveforms to be measured to an easy-to-observe position.
2. Set the cursor mode to ΔT .
3. Adjust the Δ REF cursor to the left edge of the pulse signal to be measured, and the Δ cursor to the right edge.
4. Measured value is displayed in the upper right part on the screen.

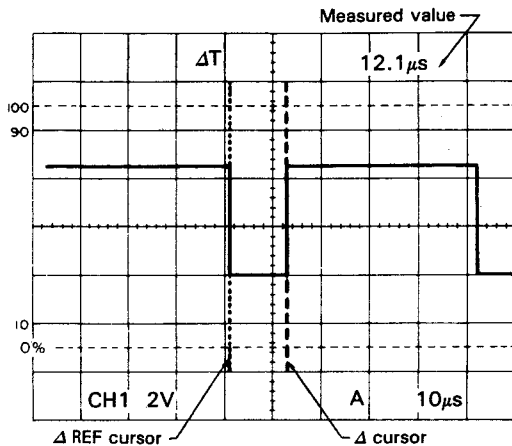

Fig. 29

8. PULSE RISETIME AND FALLTIME MEASUREMENTS

(1) Ordinary measurement

For risetime and falltime measurements, the 10% and 90% amplitude points are used as starting and ending reference points.

Procedure:

1. Apply a signal to the INPUT jack. Set the vertical MODE to the channel to be used.
Use the VOLTS/DIV and VARIABLE to adjust the waveform peak-to-peak height to five divisions.
2. Using the \blacktriangleleft POSITION control and the other controls, adjust the display such that the waveform is centered vertically in the display. Set the SWEEP TIME/DIV to as fast a setting as possible consistent with observation of both the 10% and 90% points. Set the SWEEP VARIABLE control to CAL position.
3. Use the \blacktriangleleft POSITION control to adjust the 10% point to coincide with a vertical graduation line and measure the distance in divisions between the 10% and 90% points on the waveform. Multiply this by the SWEEP TIME/DIV and also by 1/10, if "x 10 MAG" mode was used.

NOTE: The graticule on the CRT includes the 0, 10, 90, and 100% lines assuming that 5 divisions correspond to 100%. Use them as a reference for accurate meas-

urements.

Using the formula:

$$\text{Risetime} = \text{Horizontal distance (div)} \times (\text{SWEEP TIME/DIV setting}) \times " \times 10 \text{ MAG} " \text{ value}^{-1} (1/10)$$

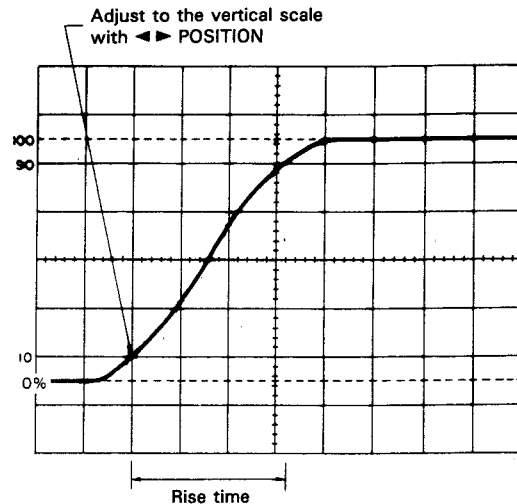

Fig. 30

[EXAMPLE]

For the example, the horizontal distance is 3.3 divisions. The SWEEP TIME/DIV is 2 ($\mu\text{s}/\text{div}$). (See Fig. 30)

Substituting the given value:

$$\text{Risetime} = 3.3 (\text{div}) \times 2 (\mu\text{s}/\text{div}) = 6.6 \mu\text{s}$$

Risetime and falltime can be measured by making use of the alternate step 3 as described below as well.

4. Use the \blacktriangleleft POSITION control to set the 10% point to coincide with the center vertical graduation line and measure the horizontal distance to the point of the intersection of the waveform with the center horizontal line. Let this distance be D_1 . Next adjust the waveform position such that the 90% point coincides with the vertical centerline and measure the distance from that line to the intersection of the waveform with the horizontal centerline. This distance is D_2 and the total horizontal distance is then D_1 plus D_2 for use in the above relationship in calculating the risetime or falltime.

Using the formula:

$$\text{Risetime} = (D_1 + D_2) (\text{div}) \times (\text{SWEEP TIME/DIV setting}) \times " \times 10 \text{ MAG} " \text{ value}^{-1} (1/10)$$

9. PHASE DIFFERENCE MEASUREMENTS

(1) Ordinary measurement

Phase difference between two sine waves of the same frequency, etc. can be measured as follows:

Procedure:

1. Apply the two signals to the CH1 and CH2 INPUT jacks, setting the vertical MODE to either CHOP or ALT mode.
2. Set the controls to obtain normal sweep. Set the SOURCE switch to select the signal which is leading in phase (reference signal), and adjust the VOLTS/DIV and vertical VARIABLE controls such that the two signals are equal in amplitude.
3. Use the SWEEP TIME/DIV and SWEEP VARIABLE to adjust the display such that one cycle of the signals occupies 8 divisions of horizontal display. Operate \blacktriangledown POSITION to shift the two signals on the center of the scale. Having set up the display as above, one division now represents 45° in phase.
4. Measure the horizontal distance between corresponding points on the two waveforms.

Using the formula:

$$\text{Phase difference} = \text{Horizontal distance (div)} \times 45^\circ/\text{div}$$

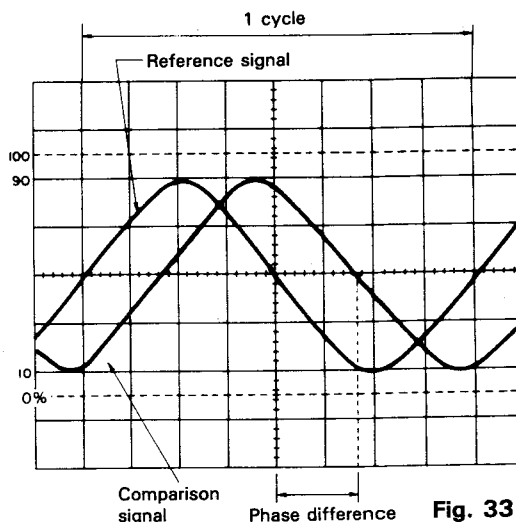

Fig. 33

[EXAMPLE]

For the example, the horizontal distance is 1.7 divisions. (See Fig. 33)

Substituting the given value:

$$\text{The phase difference} = 1.7 (\text{div}) \times 45^\circ/\text{div} = 78.5^\circ$$

The above setup allows 45° per division but if more accuracy is required the SWEEP TIME/DIV may be changed and magnified without touching the VARIABLE control and if necessary the trigger level can be readjusted.

In this case, the phase difference can be obtained from the SWEEP TIME/DIV setting for 8 divisions/cycle and the new SWEEP TIME/DIV setting changed for higher accuracy, by using the following formula.

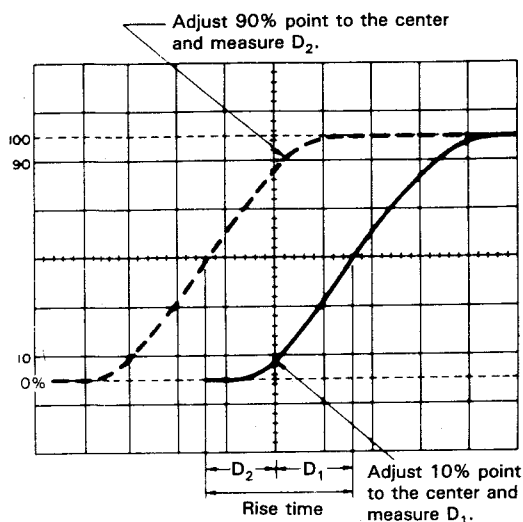

Fig. 31

[EXAMPLE]

For the example, the measured D_1 is 1.6 divisions while D_2 is 1.4 divisions. If SWEEP TIME/DIV is $2 \mu\text{s}/\text{div}$ we use the following relationship. (See Fig. 31)

Substituting the given value:

$$\text{Risetime} = (1.6 + 1.4) (\text{div}) \times 2 (\mu\text{s}/\text{div}) = 6 \mu\text{s}$$

(2) Cursor measurement (CS-5130 only)

1. In the same way as the ordinary measurement, adjust the waveform height displayed on the screen to 5 divisions, and align the bottom and top of the waveform with 0% and 100% respectively using the \blacktriangledown POSITION switches.
2. Set the cursor mode to ΔT .
3. Adjust the Δ REF cursor to the crossing of the waveform and the 10% division of the scale, and the Δ cursor to the crossing of the waveform and the 90% division.
4. Measured value is displayed in the upper right part on the screen.

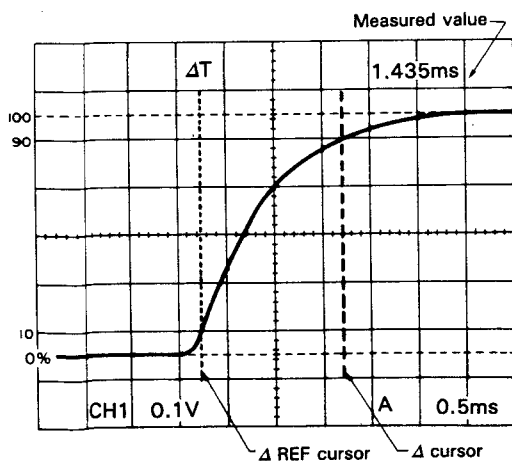
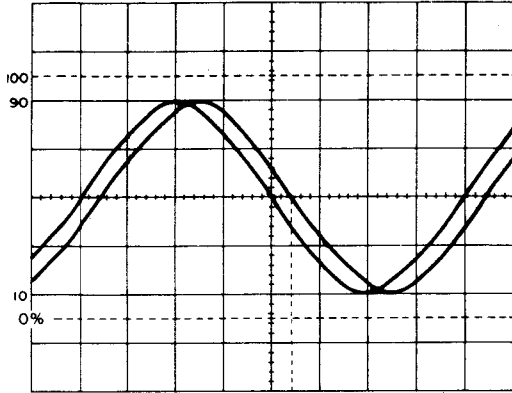

Fig. 32

Phase difference = Horizontal distance of new sweep range
(div) $\times 45^\circ/\text{div}$

$$\times \frac{\text{New SWEEP TIME/DIV setting}}{\text{Original SWEEP TIME/DIV setting}}$$

Another simple method of obtaining more accuracy quickly is to simply use $\times 10$ MAG for a scale of $4.5^\circ/\text{div}$.



Phase difference

One cycle adjusted to occupy 8 div.

Fig. 34

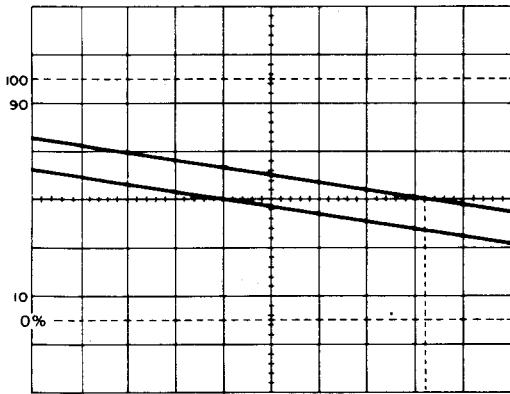

Phase difference

Expanded sweep waveform display.

Fig. 35

(2) Cursor measurement (CS-5130 only)

1. In ordinary procedures 1 and 2, adjust waveforms to be measured to an easy-to-observe position.
2. Adjust 1 cycle's waveform to 5 divisions with the SWEEP TIME/DIV. VARIABLE controller. Then move two waveforms to the center of the scale with the \updownarrow POSITION switches.

3. Set the cursor mode to $1/\Delta T$.

NOTE: When the SWEEP TIME VARIABLE switch is set to UNCAL, the unit is set to PHASE measurement mode.

4. Bring the Δ REF cursor to the intersection of the phase-leading signal and center line of the horizontal scale, and bring the Δ cursor to the intersection of the phase-lagging signal and center line of the horizontal scale.

5. Measured value is displayed in the upper right part on the screen.

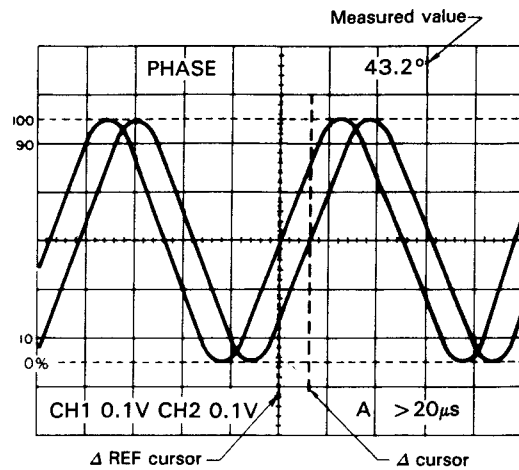

Fig. 36

10. TIME RATIO MEASUREMENT USING CURSORS (CS-5130 only)

Duty ratio of square waves can be measured as follows:

1. Supply signal into the INPUT terminal. Set the V. MODE switch to the channel to be used, the AC-GND-DC selector switch to DC, and each switch so that ordinary sweep is displayed. Then adjust the VOLTS/DIV and SWEEP TIME/DIV for easy waveform observation.

2. Turn the SWEEP TIME VARIABLE switch on to adjust 1 cycle's waveform to 5 divisions on the screen with the $\blacktriangleleft \blacktriangleright$ POSITION switches as necessity requires.

NOTE: When the SWEEP TIME VARIABLE switch is set to UNCAL, the unit is set to RATIO measurement mode.

3. Set the cursor mode to ΔT .

4. Adjust the Δ REF cursor to the left of the two points to be measured, and the Δ cursor to the right.

5. Duty ratio with respect to the 5 div (100%) point is displayed percentagewise in the upper right part on the screen.

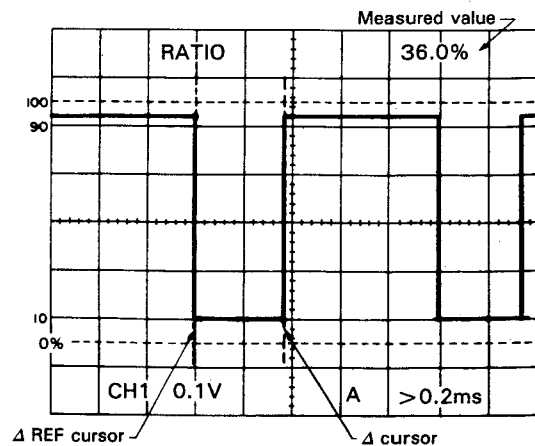

Fig. 37

11. FREQUENCY MEASUREMENTS

Frequency measurements are made by measuring the period of one cycle of waveform and taking the reciprocal of this time value as the frequency.

Procedure:

1. Following the procedure described in section 5 "Time Measurements", measure the time of each cycle. The figure obtained in the signal period.
2. The frequency is the reciprocal of the period measured.

Using the formula:

$$\text{Freq} = \frac{1}{\text{period}}$$

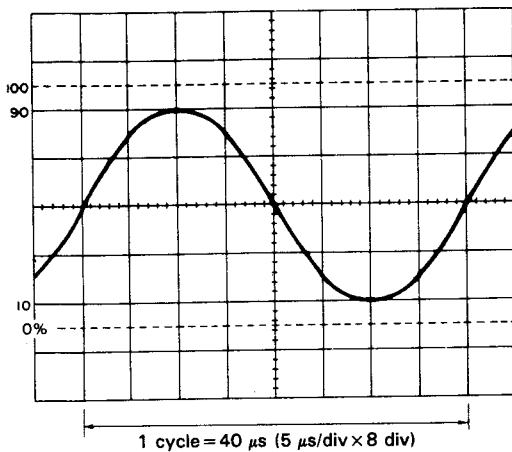

Fig. 38

[EXAMPLE]

A period of 40 μs is observed and measured. (See Fig. 38)

Assuming that SWEEP TIME/DIV indicates 5 $\mu\text{s}/\text{div}$, substituting the given Value:

$$\text{Freq} = 1/[40 \times 10^{-6}] = 2.5 \times 10^4 = 25 \text{ kHz}$$

While the above method relies on the measurement directly of the period of one cycle, the frequency may also be measured by counting the number of cycles present in a given time period.

1. Apply the signal to the INPUT jack. Set the vertical MODE to the channel to be used and adjusting the various controls for a normal display. Set the VARIABLE control to CAL position.
2. Count the number of cycles of waveform between a chosen set of graticules in the vertical axis direction. Using the horizontal distance between the vertical lines used above and the SWEEP TIME/DIV, the time span may be calculated. Multiply the reciprocal of this value by the number of cycles present in the given time span. If "x10 MAG" is used multiply this further by 10. Note that errors will occur for displays having only a few cycles.

Using the formula:

$$\text{Freq} = \frac{\# \text{ of cycles} \times " \times 10 \text{ MAG} " \text{ value}}{\text{Horizontal distance (div)} \times \text{SWEEP TIME/DIV setting}}$$

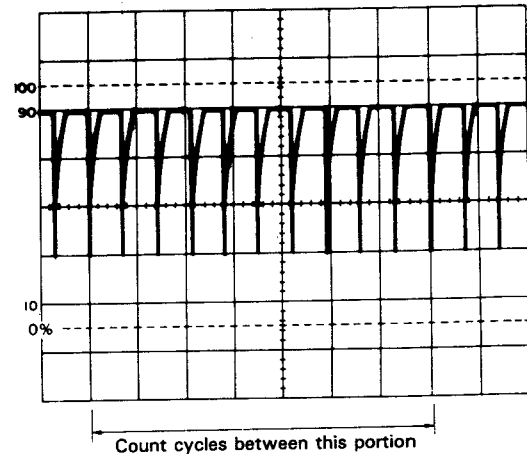

Fig. 39

[EXAMPLE]

For the example, within 7 divisions there are 10 cycles. The SWEEP TIME/DIV is 5 $\mu\text{s}/\text{div}$. (See Fig. 39)

Substituting the given value:

$$\text{Freq} = \frac{10}{7 \text{ (div)} \times 5 \text{ (}\mu\text{s/div)}}$$

$$\approx 285.7 \text{ kHz}$$

Cursor measurement (CS-5130 only)

1. Apply the signal to INPUT jack, setting the vertical MODE switch to the channel to be used and adjusting the various controls for a normal display. VOLTS/DIV and SWEEP TIME/DIV to obtain an easily observed display. Set the VARIABLE to CAL.
2. Set the cursor mode to $1/\Delta T$.
3. Adjust the Δ REF cursor to the left of the points to be measured, and the Δ cursor to the right.
4. Measured value is displayed in the upper part on the screen posterior to $1/\Delta T$.

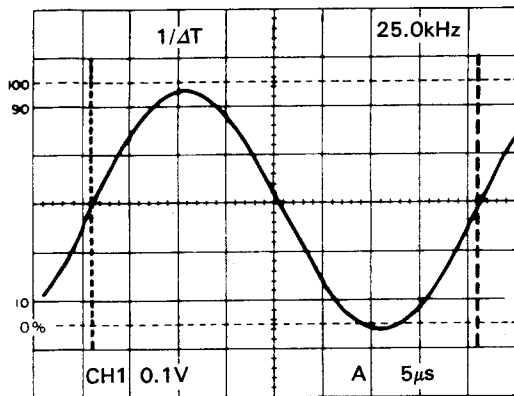

Fig. 40

12. RELATIVE MEASUREMENTS

If the frequency and amplitude of some reference signal are known, an unknown signal may be measured for level and frequency without use of the VOLTS/DIV or SWEEP TIME/DIV for calibration.

The measurement is made in units relative to the reference signal.

★ Vertical Sensitivity

Setting the relative vertical sensitivity using a reference signal.

Procedure:

1. Apply the reference signal to the INPUT jack and adjust the display for a normal waveform display. Adjust the VOLTS/DIV and VARIABLE so that the signal coincides with the CRT face's graduation lines. After adjusting, be sure not to disturb the setting of the VARIABLE control.
2. The vertical calibration coefficient is now the reference signal's amplitude (in volts) divided by the product of the vertical amplitude set in step 1 and the VOLTS/DIV setting.

Using the formula:

Vertical coefficient

$$= \frac{\text{Voltage of the reference signal (V)}}{\text{Vertical amplitude (div)} \times \text{VOLTS/DIV setting}}$$

3. Remove the reference signal and apply the unknown signal to the INPUT jack, using the VOLTS/DIV control to adjust the display for easy observation. Measure the amplitude of the displayed waveform and use the following relationship to calculate the actual amplitude of the unknown waveform.

Using the formula:

$$\begin{aligned} \text{Amplitude of the unknown signal (V)} \\ = \text{Vertical distance (div)} \times \text{Vertical coefficient} \\ \times \text{VOLTS/DIV setting} \end{aligned}$$

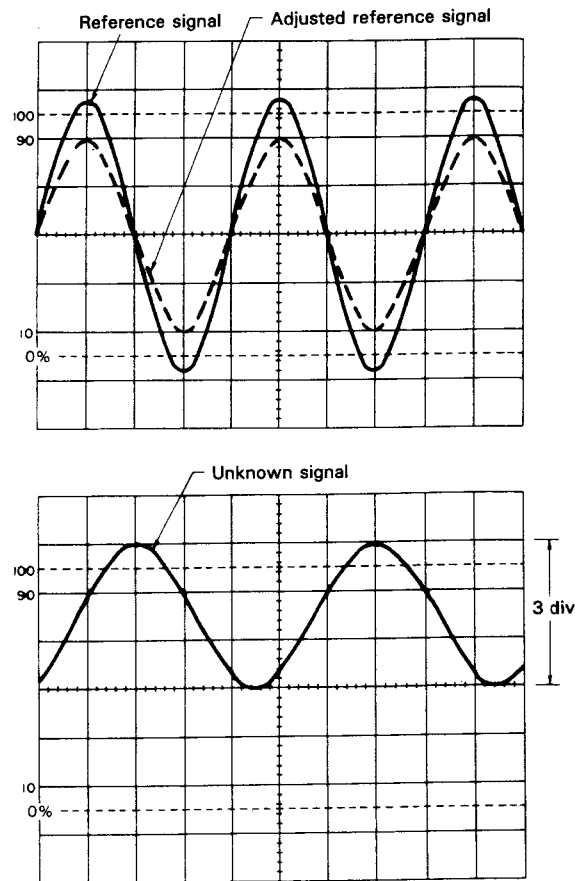

Fig. 41

[EXAMPLE]

For the example, the VOLTS/DIV is 1 V/div. The reference signal is 2 Vrms. Using the VARIABLE, adjust so that the amplitude of the reference signal is 4 divisions. (See Fig. 41)

Substituting the given value:

$$\begin{aligned} \text{Vertical coefficient} &= \frac{2 \text{ Vrms}}{4 \text{ (div)} \times 1 \text{ (V/div)}} \\ &= 0.5 \end{aligned}$$

Then measure the unknown signal and VOLTS/DIV is 5 V and vertical amplitude is 3 divisions.

Substituting the given value:

$$\begin{aligned} \text{Effective value of unknown signal} &= 3 \text{ (div)} \times 0.5 \times 5 \text{ (V/div)} \\ &= 7.5 \text{ V rms} \end{aligned}$$

★ Period

Setting the relative sweep coefficient with respect to a reference frequency signal.

Procedure:

1. Apply the reference signal to the INPUT jack, using the VOLTS/DIV and VARIABLE to obtain an easily observed waveform display. Using the SWEEP TIME/DIV and VARIABLE adjust one cycle of the reference signal to occupy a fixed number of scale divisions accurately. After this is done be sure not to disturb the setting of the VARIABLE control.

2. The Sweep (horizontal) calibration coefficient is then the period of the reference signal divided by the product of the number of divisions used in step 1 for setup of the reference and the setting of the SWEEP TIME/DIV control.

Using the formula:
Sweep coefficient

$$= \frac{\text{Period of the reference signal (sec)}}{\text{horizontal width (div)} \times \text{SWEEP TIME/DIV setting}}$$

3. Remove the reference signal and input the unknown signal, adjusting the SWEEP TIME/DIV control for easy observation.

Measure the width of one cycle in divisions and use the following relationship to calculate the actual period.

Using the formula:

$$\text{Period of unknown signal} = \text{Width of 1 cycle (div)} \times \text{sweep coefficient} \times \text{SWEEP TIME/DIV setting}$$

Adjusted reference signal Reference signal

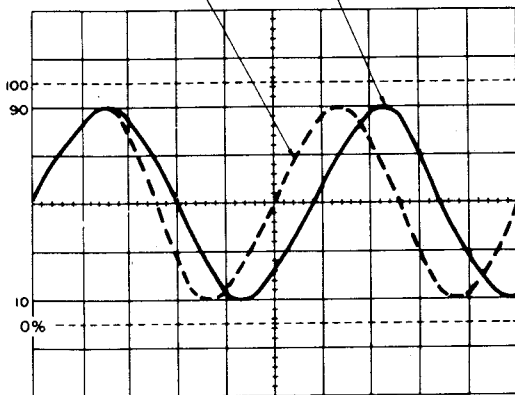
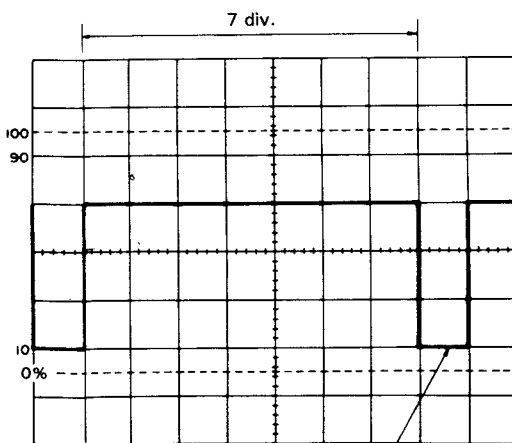

Fig. 42



Unknown signal

Fig. 43

[EXAMPLE]

SWEEP TIME/DIV is 0.1 ms and apply 1.75 kHz reference signal. Adjust the VARIABLE so that the distance of one cycle is 5 divisions.

Substituting the given value:

$$\text{Horizontal coefficient} = \frac{1.75 \text{ (kHz)} - 1}{5 \text{ (div)} \times 0.1 \text{ (ms/div)}} \approx 1.143$$

Then, SWEEP TIME/DIV is 0.2 ms/div and horizontal amplitude is 7 divisions. (See Fig. 43)

Substituting the given value:

$$\text{Pulse width} = 7 \text{ (div)} \times 1.143 \times 0.2 \text{ (ms/div)} \approx 1.6 \text{ ms}$$

13. PULSE JITTER MEASUREMENT

1. Apply the signal to the INPUT jack and set the vertical MODE to the channel to be used. Use the VOLTS/DIV to adjust for an easy to observe waveform display. Special care should be taken to adjust the trigger group of controls for a stable display. Set the SWEEP VARIABLE to CAL position.
2. Set the HORIZ MODE switch to ALT, and depress the HOLD OFF control. Adjust the DELAY TIME POSITION for intensified display of the waveform to be measured.
3. Using the B SWEEP TIME/DIV adjust the display for intensification of the entire jitter area of the waveform.
4. Set the HORIZ MODE to B. Measure the width of the jitter area. The jitter time is this width in division multiplied by the setting of the B SWEEP TIME/DIV control.

Using the formula:

$$\text{Pulse jitter} = \text{Jitter width (div)} \times \text{B SWEEP TIME/DIV setting}$$

[EXAMPLE]

The example shows a case in which the jitter width was measured at 1.6 divisions wide with the B SWEEP TIME/DIV set at 0.2 μs. (See Fig. 44)

Substituting the given value:

$$\text{Pulse jitter} = 1.6 \text{ (div)} \times 0.2 \text{ (}\mu\text{s)} = 0.32 \mu\text{s}$$

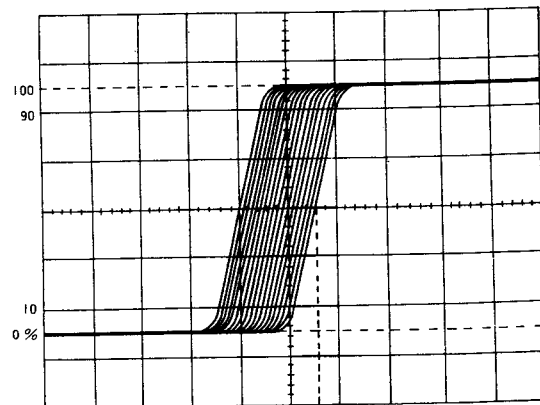

Pulse jitter

Fig. 44

14. SWEEP MULTIPLICATION (MAGNIFICATION)

The apparent magnification of the delayed sweep is determined by the values set by the A and B SWEEP TIME/DIV controls.

1. Apply a signal to the INPUT jack and set the vertical MODE to the channel to be used, adjusting VOLTS/DIV for an easily observed display of the waveform and the other controls if necessary.
2. Set the A SWEEP TIME/DIV so that several cycles of the waveform are displayed. Depress the HOLD OFF control to (AFTER DELAY).

When the HORIZ MODE is set to INT, the magnified portion of the waveform will appear intensified on the CRT display.

3. Use the DELAY TIME MULT to shift the intensified portion of waveform to correspond with the section to be magnified for observation. Use the B SWEEP TIME/DIV to adjust intensified portion to cover the entire portion to be magnified.
4. Set the HORIZ MODE to either ALT or B and use the \blacktriangledown POSITION and TRACE SEPARATION controls to adjust the display for easy viewing.
5. Time measurements are performed in the same manner from the B sweep as was described above for A sweep time measurements.

The apparent magnification of the intensified waveform section is the A SWEEP TIME/DIV divided by the B SWEEP TIME/DIV.

Using the formula:

The apparent magnification of the intensified waveform = $\frac{\text{A SWEEP TIME/DIV setting}}{\text{B SWEEP TIME/DIV setting}}$

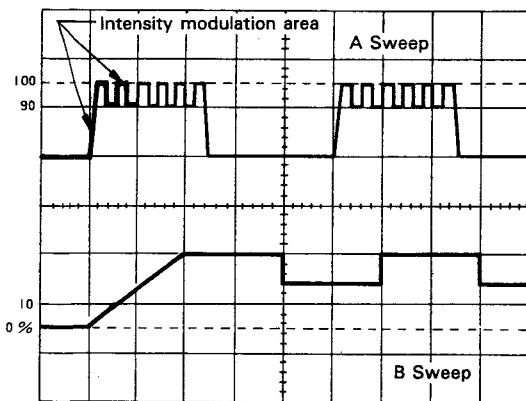

Fig. 45

[EXAMPLE]

In the example, the A SWEEP TIME is $2 \mu\text{s}$ and the B SWEEP TIME is $0.2 \mu\text{s}$. (See Fig. 45)

Substituting the given value:

$$\text{Apparent magnification ratio} = \frac{2 \times 10^{-6}}{0.2 \times 10^{-6}} = 10$$

With the above magnification, if the magnification ratio is increased, delay jitter will occur.

To achieve a stable display, set the B MODE to TRIG and used the triggered mode of operation.

1. Perform the above steps 1 through 3.
2. Pull the HOLD OFF control to activate B TRIG'D function.
3. Set the HORIZ MODE to either ALT or B. The apparent magnification will be the same as described above.

15. APPLICATION OF X-Y OPERATION

★ Phase Shift Measurement

A method of phase measurement requires calculations based on the Lissajous patterns obtained using X-Y operations. Distortion due to non-linear amplification also can be displayed.

A sine wave input is applied to the audio circuit being tested. The same sine wave input is applied to the vertical input of the oscilloscope, and the output of the tested circuit is applied to the horizontal input of the oscilloscope. The amount of phase difference between the two signals can be calculated from the resulting waveform.

To make phase measurements, use the following procedure.

1. Using an audio signal generator with a pure sinusoidal signal, apply a sine wave test signal at the desired test frequency to the audio network being tested.
2. Set the signal generator output for the normal operating level of the circuit being tested. If desired, the circuit's output may be observed on the oscilloscope. If the test circuit is overdriven, the sine wave display on the oscilloscope is clipped and the signal level must be reduced.
3. Connect the channel 2 probe to the output of the test circuit.
4. Select X-Y operation by placing the TRIG MODE switch in the X-Y position.
5. Connect the channel 1 probe to the input of the test circuit.
(The input and output test connections to the vertical and horizontal oscilloscope inputs may be reserved.)
6. Adjust the channel 1 and 2 gain controls for a suitable viewing size.
7. Some typical results are shown in Fig. 47.

If the two signals are in phase, the oscilloscope trace is a straight diagonal line. If the vertical and horizontal gain are properly adjusted, this line is at a 45° angle. A 90° phase shift produces a circular oscilloscope pattern. Phase shift of less (or more) than 90° produces an elliptical oscilloscope pattern. The amount of phase shift can be calculated from the oscilloscope trace as shown in Fig. 57.

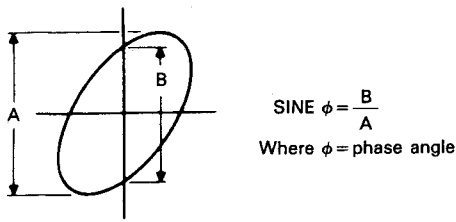

Fig. 46 Phase shift calculation









		
No amplitude distortion, no out of phase	Amplitude distortion, no out of phase	180° out of phase
		
No amplitude distortion, out of phase	Amplitude distortion, out of phase	90° out of phase

Fig. 47 Typical phase measurement oscilloscope display

★ **Frequency Measurement**

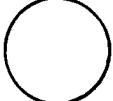
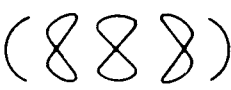
1. Connect the sine wave of known frequency to the channel 2 INPUT jack of the oscilloscope and select X—Y operation. This provides external horizontal input.
2. Connect the vertical input probe (CH1 INPUT) to the unknown frequency.
3. Adjust the channel 1 and 2 size controls for convenient, easy-to-read size of display.
4. The resulting pattern, called a Lissajous pattern, shows the ratio between the two frequencies.

Unknown frequency to Vertical input, Standard frequency to Horizontal input	Ratio of unknown to standard
See note 	1/2:1
See note 	1:1
	1-1/2:1
	6:1

Note: Any one of these figures, depending upon phase relationship

Fig. 48 Lissajous waveforms used for frequency measurement

MAINTENANCE

⚠ Caution : Read this page carefully to keep your safety.

For Electric Shock Protection:

Be sure to disconnect the power cable from the socket before conducting the following operation.

REPLACING THE FUSE

In case the fuse has blown, locate the cause. If the fuse itself is the cause, replace it as follows:

1. Pull the plug of the power cord from the power outlet.
2. Remove the fuse holder in the rear panel using a standard screwdriver (see Fig. 49).
3. Take out the blown fuse, and in its place, insert a new fuse.
4. Set the label of your line voltage to the mark ▼, then plug the fuse holder containing the new fuse into the rear panel.

CHANGING THE SUPPLY VOLTAGE

Remove the fuse holder in the rear panel using a standard screwdriver. Then set the label of your line voltage to the mark ▼ and plug the fuse holder back into place. When changing the supply setting from 100/120 V to 220/240 V, change the 1 A fuse for a 0.5 A one. (see Fig. 49)

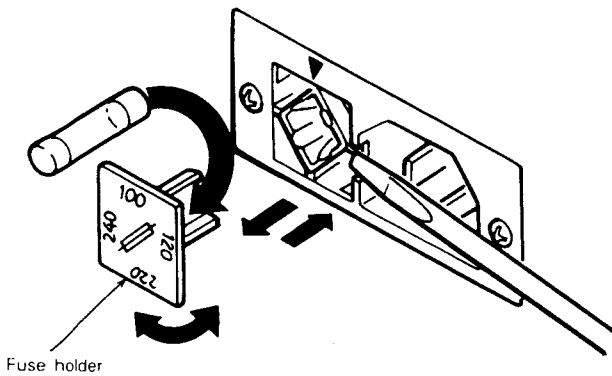

Fig. 49

ACCESSORIES

STANDARD ACCESSORIES INCLUDED

CS-5130	
Probe (PC-33) (for READ OUT)	W03-2307-05
Attenuation	1/10
Input Impedance	10 M Ω , 22 pF \pm 10%
Instruction Manual	B50-7667-00
Replacement Fuse	
1 A	F05-1023-05
0.5 A	F05-5013-05
CS-5135	
Probe (PC-30)	W03-2308-05
Attenuation	1/10, 1/1
Input Impedance	
1/10	10 M Ω , 22pF \pm 10%
1/1	1 M Ω , 200pF or less
Instruction Manual	B50-7667-00
Replacement Fuse	
1 A	F05-1023-05
0.5 A	F05-5013-05

OPTIONAL ACCESSORIES

Probe Pouch (MC-78)	Y87-1600-00
---------------------	-------------

This soft vinyl pouch attaches to the top side oscilloscope housing and provides storage space for two probes and the operators manual. Install the probe pouch as follow;

1. Unsnap the probe pouch from the retainer plate.
2. Align the retainer plate with 4 holes on the top side of the case, with 4 snaps at the top.
3. Attach the 4 corners of the retainer plate to the oscilloscope case with the 4 nylon rivets supplied.
4. Attach the pouch to the retainer plate using the snap fastener.

